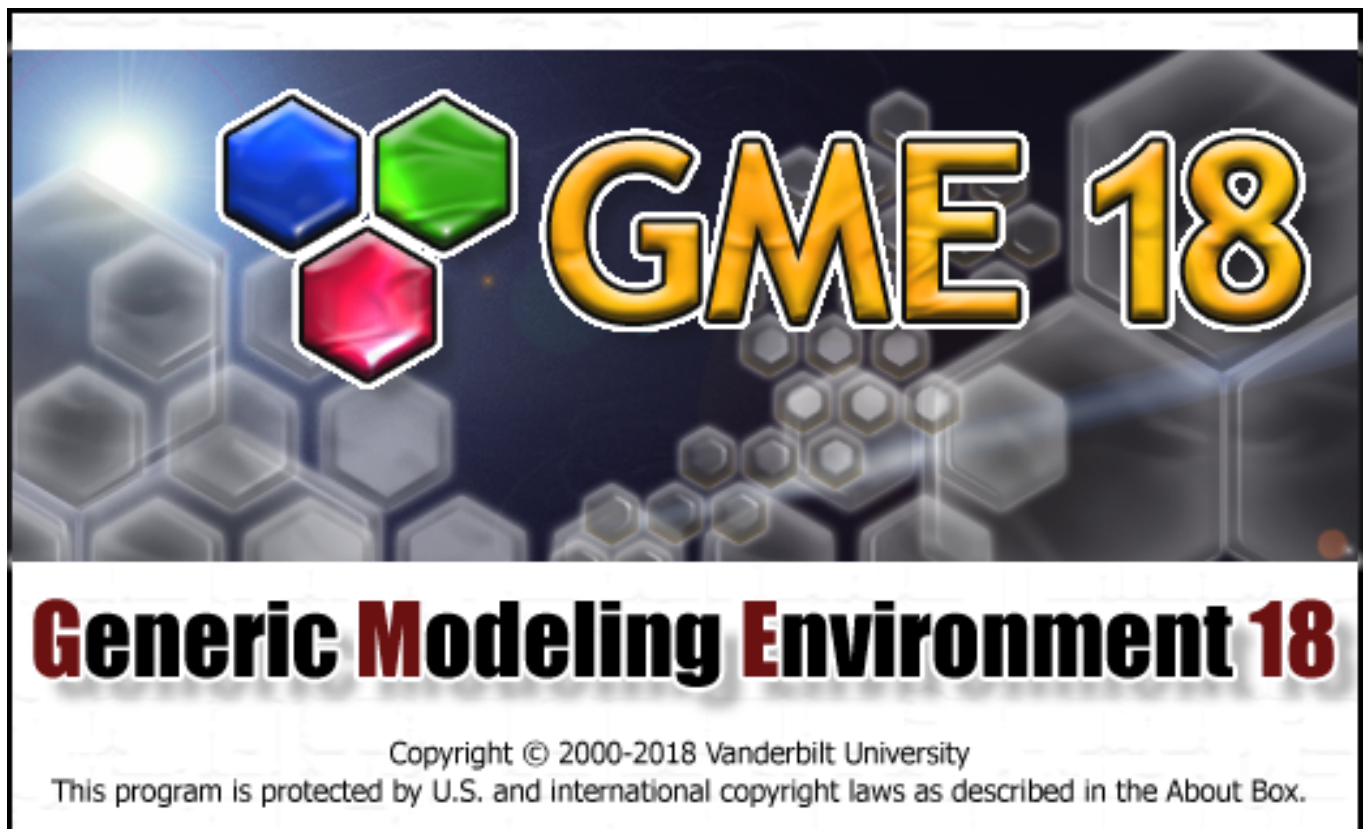

GME Manual and User Guide

<http://www.isis.vanderbilt.edu>

Copyright © 2000-2018 Vanderbilt University

All rights reserved

Abstract



The Generic Modeling Environment

Table of Contents

1. Introduction	4
2. Modeling Concepts Overview	5
2.1. Model-Integrated Program Synthesis	5
2.2. The MultiGraph Architecture	5
3. The Generic Modeling Environment	7
3.1. GME Main Editing Window	7
3.2. GME Concepts	8
4. Using GME	15
4.1. GME Interfaces	15
4.2. The Part Browser	15
4.3. The Attribute Browser	15
4.4. The Model Browser	16

4.5. The Model Editor	18
4.6. Annotations	23
4.7. Managing Paradigms	24
4.8. Editor Operations	25
4.9. AutoRouter Features	28
4.10. Emergency saves and GME CrashDumps	32
4.11. Help System	33
4.12. Searching Objects	34
4.13. Scripting in GME	36
5. Type Inheritance	39
5.1. Attributes and Preferences	41
6. Libraries	42
6.1. Library Refresh	42
6.2. Libraries and Metamodeling	43
7. Decorators	46
7.1. The <code>IMgaElementDecorator</code> interface	46
7.2. The <code>IMgaElementDecoratorEvents</code> interface	51
7.3. Visual Studio 2008 Decorator Wizard	55
7.4. Using the Decorator sample/skeleton codes	56
7.5. Using the <code>DecoratorLib</code> library	56
7.6. Assigning decorators to objects	58
8. Metamodeling Environment	59
8.1. Step by step guide to basic metamodeling	59
8.2. Composing Metamodels	63
8.3. Generating the Target Modeling Paradigm	65
8.4. Attribute Guide	65
8.5. Metamodeling Semantics	71
9. High-Level Component Interface	74
9.1. Builder Object Network version 1.0	74
9.2. Meta Object Network	82
9.3. Builder Object Network version 2.0	86
9.4. How to create a new component project	99
9.5. Extending the Component Interface using the BON Extender interpreter	99
10. Constraint Manager	103
10.1. Features of the new Constraint Manager	103
10.2. Using Constraints in GME	109
A. OCL and GME	118
1. OCL Language	119
1.1. Type Conformance	119
1.2. Context of a Constraint	119
1.3. Types of Constraints (Expressions)	120
1.4. Common OCL Expressions	121
1.5. Type Related Expressions	125
1.6. Resolution Rules	129
2. Predefined OCL Types	133
2.1. <code>ocl::Any</code>	133
2.2. <code>ocl::String</code>	134
2.3. <code>ocl::Enumeration</code>	135
2.4. <code>ocl::Boolean</code>	135
2.5. <code>ocl::Real</code>	136
2.6. <code>ocl::Integer</code>	138
2.7. <code>ocl::Type</code>	139
2.8. <code>ocl::Collection</code>	139
2.9. <code>ocl::Set</code>	141

2.10. ocl::Bag	142
2.11. ocl::Sequence	143
3. GME Kinds and Meta-Kinds	146
3.1. gme::Object	146
3.2. gme::Folder	147
3.3. gme::FCO	147
3.4. gme::Connection	150
3.5. gme::Reference	150
3.6. gme::Set	151
3.7. gme::Atom	151
3.8. gme::Model	151
3.9. gme::Project	152
3.10. gme::RootFolder	152
3.11. gme::ConnectionPoint	153
Glossary	154

1. Introduction

The Generic Modeling Environment (GME), is a Windows®-based, domain-specific, model-integrated program synthesis tool for creating and evolving domain-specific, multi-aspect models of large-scale engineering systems. The GME is *configurable*, which means it can be “programmed” to work with vastly different domains. Another important feature is that GME paradigms are generated from formal modeling environment specifications.

The GME includes several other relevant features:

- It is used primarily for *model-building*. The models take the form of graphical, multi-aspect, attributed entity-relationship diagrams. The dynamic *semantics* of a model is not the concern of GME – that is determined later during the *model interpretation* process.
- It supports various techniques for building large-scale, complex models. The techniques include: hierarchy, multiple aspects, sets, references, and explicit constraints. These concepts are discussed later.
- It contains one or more integrated model interpreters that perform translation and analysis of models currently under development.

In this document we describe the commonalities of GME that are present in all manifestations of the system. Hence, we deal with general questions, and not domain-specific modeling issues. The following sections describe some general modeling concepts and the various functions of the GME.

2. Modeling Concepts Overview

2.1. Model-Integrated Program Synthesis

One approach to MIC is model-integrated program synthesis (MIPS). A MIPS environment operates according to a domain-specific set of requirements that describe how any system in the domain can be modeled. These modeling requirements specify the types of entities and relationships that can be modeled; how to model them; entity and/or relationship attributes; the number and types of aspects necessary to logically and efficiently partition the design space; how semantic information is to be represented in, and later extracted from, the models; analysis requirements; and, in the case of executable models, run-time requirements.

In MIPS, formalized models capture various aspects of a domain-specific system's desired structure and behavior. Model interpreters are used to perform the computational transformations necessary to synthesize executable code for use in the system's execution environment—often in conjunction with code libraries and some form of middleware (e.g. CORBA, the MultiGraph kernel, POSIX) – or to supply input data streams for use by various GOTS, COTS, or custom software packages (e.g. spreadsheets, simulation engines) When changes in the overall system require new application programs, the models are updated to reflect these changes, the interpretation process is repeated, and the applications and data streams are automatically regenerated from the models.

Once a modeling paradigm has been established, the MIPS environment itself can be built. A MIPS environment consists of three main components: (1) a domain aware model builder used to create and modify models of domain-specific systems, (2) the models themselves, and (3) one or more model interpreters used to extract and translate semantic knowledge from the models.

2.2. The MultiGraph Architecture

The MultiGraph Architecture (MGA) is a toolset for creating MIPS environments. As mentioned earlier, MIPS environments provide a means for evolving domain-specific applications through the modification of models and re-synthesis of applications. We now discuss the creation of a MIPS environment.

2.2.1. The Modeling Paradigm

The process begins by formulating the domain's modeling paradigm. The modeling paradigm contains all the syntactic, semantic, and presentation information regarding the domain – which concepts will be used to construct models, what relationships may exist among those concepts, how the concepts may be organized and viewed by the modeler, and rules governing the construction of models. The modeling paradigm defines the family of models that can be created using the resultant MIPS environment.

Both domain and MGA experts participate in the task of formulating the modeling paradigm. Experience has shown that the modeling paradigm changes rapidly during early stages of development, becoming stable only after a significant amount of testing and use. A contributing factor to this phenomenon is the fact that domain experts are often unable to initially specify exactly how the modeling environment should behave. Of course, as the system matures, the modeling paradigm becomes stable. However, because the system itself must evolve, the modeling paradigm must change to reflect this evolution. Changes to the paradigm result in new modeling environments, and new modeling environments require new or migrated models.

2.2.2. Metamodels and Modeling Environment Synthesis

Metamodels are models of a particular modeling environment. Metamodels contain descriptions of the entities, attributes, and relationships that are available in the target modeling environment. Once a

metamodel is constructed, it is used to configure GME. This approach allows the modeling environment itself to be evolved over time as domain modeling requirements change.

3. The Generic Modeling Environment

3.1. GME Main Editing Window

The figure below shows various features and components associated with the GME main editing window.

Figure 1. GME Main Editing Window

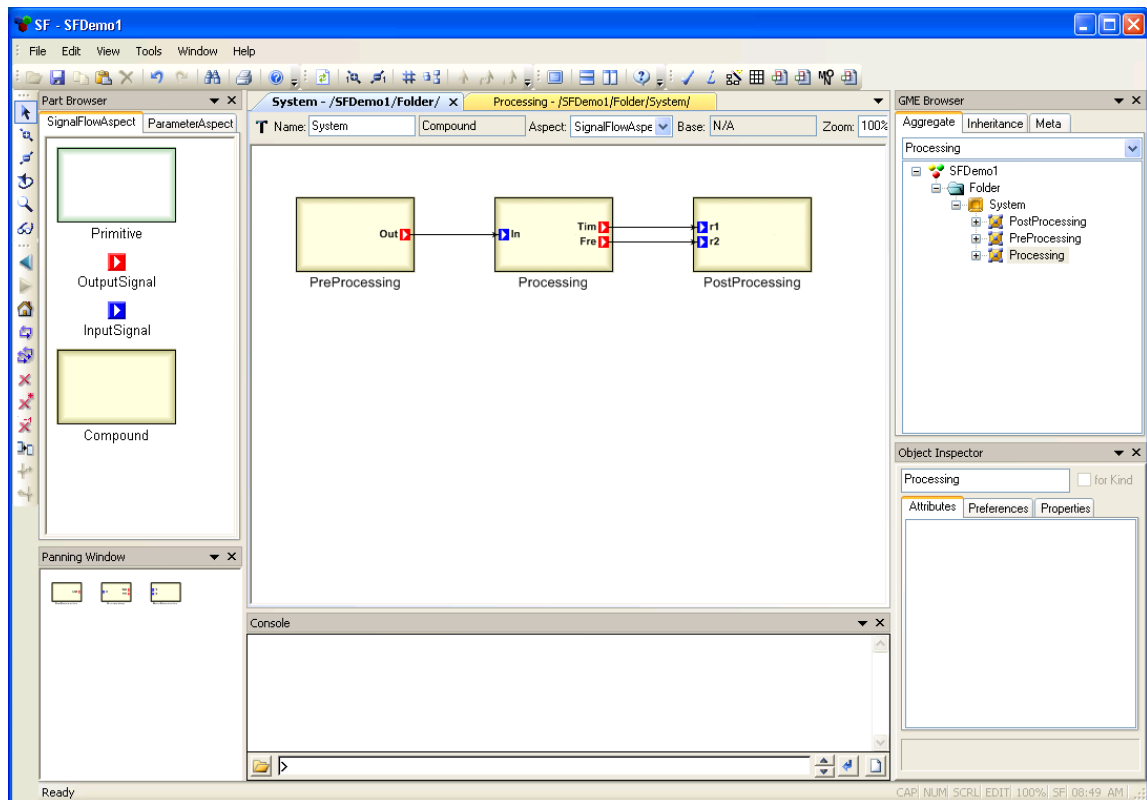

The GME main editing window has the following components:

- Titlebar: Indicates the currently loaded project.
- Menubar: Commands for certain operations on the model.
- Toolbar: Icon button shortcuts for several editing functions. Placing the mouse cursor over a toolbar button briefly displays the name/action of the button.
- Modebar: Buttons for selecting and editing modes.
- Editing area: The main model editing area containing the model editing windows.
- Partbrowser: Shows the parts that can be inserted in the current aspect of the current model.
- Statusbar: The line at the bottom, which shows status and error messages, current edit mode (e.g. EDIT, CONNECT, etc.), zoom factor, paradigm name (e.g. SF), and current time.
- Attribute Browser: Shows the attributes and preferences of an object.

- Model Browser: Shows either the aggregation hierarchy of the project, the type inheritance hierarchy of a model, or a quick overview of the current modeling paradigm.

These features will be described in detail in later sections.

3.2. GME Concepts

As mentioned above, the GME is a generic, programmable tool. However, all GME configurations are the same on a certain level, simply because “only” the domain-specific modeling concepts and model structures have changed. Before describing GME operation, we briefly describe the domain-independent modeling concepts embodied in all GME instances.

3.2.1. Defining the Modeling Paradigm

To properly model any large, complex engineering system, a modeler must be able to describe a system's entities, attributes, and relationships in a clear, concise manner. The modeling environment must constrain the modeler to create syntactically and semantically correct models, while affording the modeler the flexibility and freedom to describe a system in sufficient detail to allow meaningful analysis of the models. Issues such as what is to be modeled, how the modeling is to be done, and what types of analyses are to be performed on the constructed models must be formalized before any system is built. Such design choices are represented by the modeling paradigm. Therefore, creating the modeling paradigm is the first, and most important, step in creating a DSME.

A modeling paradigm is defined by the kind of models that can be built using it, how they are organized, what information is stored in them, etc. When GME is tailored for a particular application domain, the modeling paradigm is determined and the tool is configured accordingly. Typically the end-users do not change these paradigm definitions, and they are fixed for a particular instance of GME (of course, they may change as the design environment evolves).

Examples of modeling paradigms are as follows:

- Paradigms for modeling signal flow graphs and hardware architecture for high-performance signal processing domains.
- Paradigms for process models and equipment models used in chemical engineering domains.
- Paradigms for modeling the functionality and physical components of fault-modeling domains.
- Paradigms that describe other paradigms. These are referred to as *meta paradigms*, and are used to create *metamodels*. These metamodels are then used to automatically generate a modeling environment for the target domain.

Once an initial modeling paradigm has been formulated, an MGA expert constructs a metamodel. The metamodel is a UML-based, formal description of the modeling environment's model construction semantics. The metamodel defines what types of objects can be used during the modeling process, how those objects will appear on screen, what attributes will be associated with those objects, and how relationships between those objects will be represented. The metamodel also contains a description of any constraints that the modeling environment must enforce at model creation time. These constraints are expressed using the standard predicate logic language, Object Constraint Language (OCL) with some additional features and limitations according to metamodeling environment of GME. Note that, as mentioned earlier, metamodels are merely models of modeling environments, and as such can be built using the GME. A special metamodeling paradigm has been developed that allows metamodels to be constructed using the GME.

Once a metamodel has been created, it is used to automatically generate a domain-specific GME. The GME is then made available to one or more domain experts who use it to build domain-specific models.

Typically, the domain expert's initial modeling efforts will reveal flaws or inconsistencies in the modeling paradigm. As the modeling paradigm is refined and improved, the metamodel is updated to reflect these refinements, and new GMEs are generated.

Once the modeling paradigm is stable (i.e. the MGA and domain experts are satisfied that the GME allows consistent, valid models to be built), the task of interpreter writing begins. Interpreters are model translators designed to work with all models created using the domain-specific GME for which they were designed. The translated models are used as sources to analysis programs or are used by an execution environment.

Once the interpreters are created, environment users can create domain models and perform analysis on those models. Note, however, that model creation usually begins much sooner. Modelers typically begin creating models as soon as the initial GME is delivered. As their understanding of the modeling environment and their own systems grows, the models naturally become more complete and complex.

We now discuss the modeling components in greater detail.

3.2.2. Models

By model we mean an abstract object that represents something in the world. What a model represents depends on what domain we are working in. For instance,

- a Dataflow Block is the model for an operator in the signal processing domain,
- a Process model represents a functionality in a plant in the chemical engineering domain,
- a Network model represents a hardware interconnection scheme in the multiprocessor architecture domain.

A model is, in computational terms, an object that can be manipulated. It has state, identity, and behavior. The purpose of the GME is to create and manipulate these models. Other components of the MGA deal with interpreting these models and using them in various contexts (e.g. analysis, software synthesis, etc.).

Some modeling paradigms have several kinds of models. For instance:

- in a signal processing paradigm there can be Primitive Blocks for simple operators and Compound Blocks (which may contain both primitive blocks and other compound blocks) for compound operators.
- in a multiprocessor architecture modeling paradigm there can be models for computational Nodes and models for Networks formed from those nodes.

A model typically has *parts*—other objects contained within the model. Parts come in these varieties:

- atoms (or *atomic* parts),
- other models,
- references (which can be thought of as pointers to other objects),
- sets (which can contain other parts), and
- connections.

If a model contains parts, we say that the model is the *parent* of its parts. Parts can have various attributes. A special attribute associated with atomic parts allows them to be designated as *link* parts. Link parts act as connection points between models (usually used to indicate some form of association, relationship, or dataflow between two or more models). Models containing other models as parts are called *compound*

models. Models that cannot contain other models are called *primitive models*. If a compound model can contain other models we have a case of model *hierarchy*.

In the GME, each part (atom, model, reference, or set) is represented by an icon. Parts have a simple, paradigm-defined icon. If no icon is defined for a model, it is shown using an automatically generated rectangular icon with a 3D border.

3.2.3. Atoms

Atoms (or *atomic parts*) are simple modeling objects that do not have internal structure (i.e. they do not contain other objects), although they can have attributes. Atoms can be used to represent entities, which are indivisible, and exist in the context of their parent model.

Figure 2. A primitive model `SubGeneratorC` containing four atoms

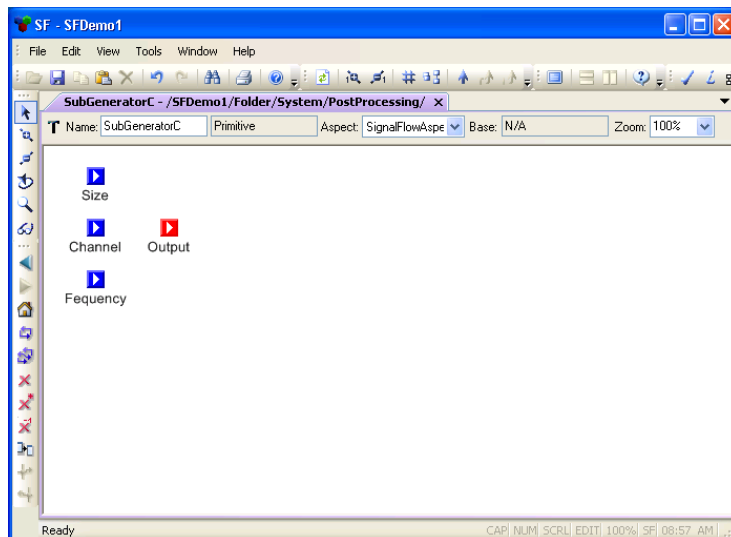

Examples of atoms are as follows:

- An output data port on a dataflow block in a signal processing paradigm.
- A connection link on a processor model in a hardware description paradigm.
- A process variable in a process model in a chemical engineering paradigm.

3.2.4. Model Hierarchy

As mentioned above, models can contain other models as parts — models of the same or different kind as the parent model. This is a case of model hierarchy. The concept can be explained as follows: models represent the world on different levels of abstraction. A model that contains other models represents something on a higher level of abstraction, since many details are not visible. A model that does not contain other models represents something on a lower level of abstraction. This hierarchical organization helps in managing complexity by allowing the modeler to present a larger part of the system, albeit with less detail, by using a higher level of abstraction. At a lower level of abstraction, more detail can be presented, but less of the system can be viewed at one time.

Examples where hierarchy is useful are as follows:

- Hierarchical dataflow diagrams in a signal processing paradigm.

- Process model hierarchy in a chemical engineering paradigm.
- Hierarchically organized networks of processors in a paradigm describing multiprocessors.

Figure 3. Compound model SuperGen containing several Generator models

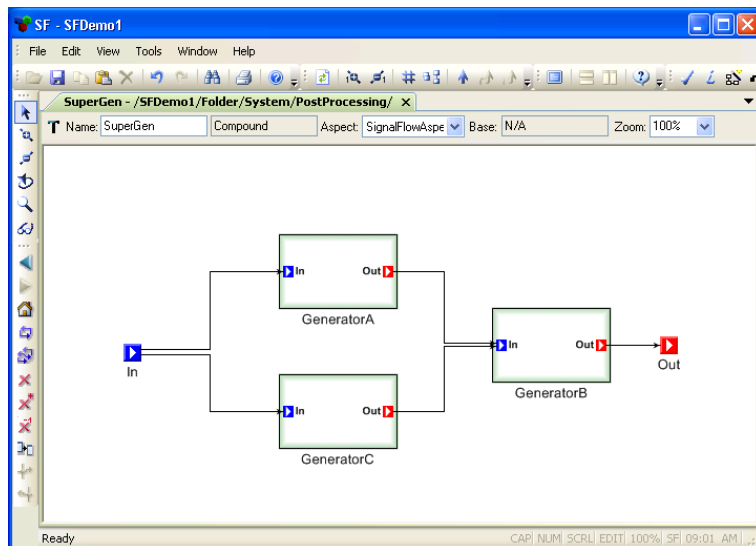

3.2.5. References

References are parts that are similar in concept to pointers found in various programming languages. When complex models are created (containing many, different kinds of atomic and hierarchical parts), it is sometimes necessary for one model to directly access parts contained in another. For example, in one dataflow diagram a variable may be defined, and in another diagram of the system one may want to use that variable. In dataflow diagrams, this is possible only by connecting that variable via a dataflow arc, “going up” in the hierarchy until a level is reached from where one can descend and reach the other diagram (a rather cumbersome process).

GME offers a better solution – *reference parts*. Reference parts are objects that refer to (i.e. *point to*) other modeling objects. Thus, a reference part can point to a model, an atomic part of a model, a model embedded in another model, or even another reference part or a set. A reference part can be created only after the referenced part has been created, and the referenced part cannot be removed until all references to it have been removed. However, it is possible to create null references, i.e. references that do not refer to any objects. One can think of these as placeholders for future use. Whether a particular reference can be established (i.e. created) or not depends on the particular modeling paradigm being used.

Examples of references are as follows:

- References to variables in remote dataflow diagrams in a signal processing paradigm.
- References to equipment models in a process model in a chemical engineering paradigm.
- References to nodes of a multiprocessor network in a paradigm describing hardware/software allocation assignments.

As mentioned above, the icon used to represent the reference part is user-defined. Model (or model reference) references that do not have their own icon defined have an appearance similar to the referred-to model, but without 3D borders.

3.2.6. Connections and links

Merely having parts in a model is not sufficient for creating meaningful models — there are relationships among those parts that need to be expressed. The GME uses many different methods for expressing these relationships, the simplest one being the *connection*. A connection is a line that connects two parts of a model. Connections have at least two attributes: *appearance* (to aid the modeler in making distinctions between different types of connections) and *directionality* (as distinguished by the presence or absence of an arrow head at the “destination” end of the line). Additional connection attributes can be defined in the metamodel, depending on the requirements of the particular modeling paradigm.

The actual semantics of a connection is determined by the modeling paradigm. When the connection is being drawn, the GME checks whether the connection is legal or not. All legal connections are defined in the metamodel. Two checks are made to determine the legality of a connection. First, a check is made to determine if the two types of objects are allowed to be connected together. Second, the direction of the connection needs to be checked.

To make connections, the modeler must place the GME in the “Add Connections” mode. This is done by clicking on the Connections mode button (see figure to left) on the Modebar. A connection always connects two parts. If the part is an icon that represents a model, it may have some connection points, or links. Logically, a link is a port through which the model is connected to another part *within the parent model*. Links on a model icon represent specific parts contained in the model that are involved in a connection. In these cases, when the connection is established, care should be taken to build the connection with the right link. The link shows up on the icon of the model part as a miniature icon with a label. When the connection is built, the system uses these miniature icons as sensitive “pads” where connections may start or end. Moving the mouse cursor over one of the pads shows the complete name of the link part. Furthermore, not only atoms, but models, sets and references except for connections can act as a ports.

Some examples of connections and links are as follows:

- Connections between dataflow blocks in a signal processing paradigm.
- Connections between processes on a process flow sheet of a chemical engineering paradigm.
- Connections between failure modes (indicating failure propagation) in a fault modeling paradigm.

Connections can be seen between atomic parts and models, as in the case of the `Input Signal` atomic part connecting to the ports labeled “In” on each of the `Generator` models shown earlier, and between ports of models, as in the case of the “Out” ports of each `Generator` model connecting to the “In” port of another `Generator` model. Notice that, in this paradigm, connections are directional (used to indicate information flow between the models).

3.2.7. Sets

Models containing objects and connections show a static system. In some cases, however, it is necessary to have a model of a *dynamic* system that has an architecture that changes over time. From the visual standpoint this means that, depending on what “state” the system is in, we should see different pictures. These “states” are not predefined by the modeling paradigm (in that case they would be aspects), but rather by the modeler. The different pictures should show the same model, containing the same kinds of parts, but some of the parts should be “present” while others should be “missing” in a certain “states.” In other words, the modeler should be able to construct sets and subsets of particular objects (even connections).

In GME, each set is represented by an icon (user-defined or default). When a particular set is activated, only the objects belonging to that set are visible (all other parts in the model are “dimmed” or “grayed out.”) Parts may belong to a single set, to more than one set, or to no set at all.

To add or remove parts from sets, the set must first be activated by placing the graphical editor into *Set Mode*. This is done by clicking the *Set Mode* button (see left) on the edit mode bar. Next, a set is activated by right-clicking the mouse on it. Once the set has been activated, parts (even connections) may be added and/or removed using the left mouse button. To return to the Edit Mode, click the *Normal Mode* button on the edit mode bar.

The following examples of using sets:

- State-dependent configuration of processing blocks in a signal processing paradigm.
- State dependent process configuration in a chemical engineering paradigm.
- State-dependent failure propagation graphs in a fault modeling paradigm.

3.2.8. Aspects

As mentioned earlier, we use hierarchy to show or hide design detail within our models. However, large models and/or complex modeling paradigms can lead to situations where, even within a given level of design hierarchy, there may be too many parts displayed at once. To alleviate this problem, models can be partitioned into *aspects*.

An aspect is defined by the kinds of parts that are visible in that aspect. Note that aspects are related to *groups* of parts. The existence or visibility of a part within a particular aspect is determined by the modeling paradigm. A given part may also be visible in more than one aspect. For every kind of part, there are two kinds of aspects: primary and secondary. Parts can only be added or deleted from the model from within its primary aspect. Secondary aspects merely *inherit* parts from the primary aspects. Of course, different interconnection rules may apply to parts in different aspects.

When a model is viewed, it is always viewed from one particular aspect at a time. Since some parts may be visible in more than one aspect while others may visible only in a single aspect, models may have a completely different appearance when viewed from different aspects (after all, that's why aspects exist!)

The following are examples of aspects:

- “Signal Flow” and “States” aspects for a signal processing paradigm.
- “Process Flow Sheet” and “Process Finite State Machine” aspects for a chemical engineering paradigm.
- “Component Assignment” and “Failure-Propagation” aspects of a fault- modeling paradigm.

3.2.9. Attributes

Models, atoms, references, sets and connections can all have *attributes*. An attribute is a property of an object that is best expressed textually. (Note that we use the word “text” for anything that is shown as text, including numbers, and a choice from a finite set of symbolic or numeric constants.)

Typically objects have multiple attributes, which can be set using “non-graphical” means, such as entry fields, menus, buttons, etc. The attribute values are translated into object values (e.g. numbers, strings, etc.) and assigned to the objects. The modeling paradigm defines what attributes are present for what objects, the ranges of the attribute values, etc. Interpreting these values is left to the model interpreters, though the users may create constraints using OCL for the attributes to ensure that their values are valid.

Examples of attributes are as follows:

- Data type of parameters in a signal processing paradigm.
- Units for process parameters in a chemical engineering paradigm.

- Mean-time-between-failure specifications for components in a fault modeling paradigm.

Figure 4. The attribute box associated with an atom called y

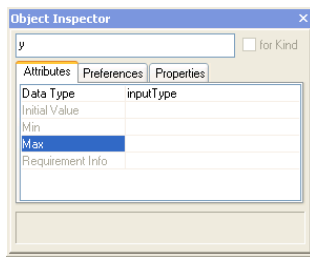

An object's attributes can be accessed by right-clicking on the object and selecting **Attributes** from the menu, causing the **Attribute Browser** to be activated.

3.2.10. Preferences

Preferences are paradigm-independent properties of objects. The five different kinds of first class objects (model, atom, reference, connection, set) each have a different set of preferences. The most important preference is the help URL. Others include color, text color, line type, etc. Preferences are inherited from the paradigm definition through type inheritance unless this chain is explicitly broken, by overriding an inherited value. For more details, see the chapter on type inheritance.

Preferences are accessible through the context menus and for the current model through the **Edit** menu.

Default preferences can be specified in the paradigm definition file (XML). User settings can be applied to either the current object, or the *kind* of object globally in the project. The checkbox in the preferences dialog box specifies this scope information. If the "for Kind" checkbox is set, the information is stored in the compiled, binary paradigm definition file, not in the XML document. This means that a subsequent parsing of the XML file overwrites preference settings. This limitation will be eliminated in a later release of GME.

Even when the global scope is selected, this only applies to objects that themselves (or any of their ancestors) have not overridden the given preference.

4. Using GME

4.1. GME Interfaces

The GME interacts with the user through two major interfaces:

- the **Model Browser**, and
- the **Graphical Editor**.

Models are stored in a model database and are organized into *projects*. A project is a group of models created using a particular modeling paradigm. Within a project, the models are further organized into modeling *folders*. Folders themselves and models in one folder can be organized hierarchically, although standalone models can also be present.

The **Model Browser** is used to view or look at the entire project “at a glance.” All models and folders can be shown, and folders, models and any kind of parts can be added, moved, and deleted using the **Model Browser** controls. This is described in more detail below.

4.2. The Part Browser

The **Part Browser** window shows the parts that can be inserted into the current model in the current aspect. It shows all parts except for connections. At the bottom of the **Part Browser**, tabs show the available aspects of the current model. Clicking on a tab will change the aspect of the current model to the selected one. It also attempts to change the aspect of all the open models. If a particular model does not have the given aspect, its current aspect remains active.

The **Part Browser** can be used to drag a single object at a time and drop it either in any editor window or in the **Model Browser**. If a reference is dragged, a null reference is created because the target object is unspecified. Remember that references (null references included) can be redirected at any time by dropping a new target on top of them (see more detailed discussion where the drag and drop operations are described).

Note that the **Part Browser** window, just like the Model Browser window, is dockable; it can float as an independent window or it can be docked to any side of the GME **Main** window.

4.3. The Attribute Browser

Attributes and **Preferences** are available in a modeless dialog box, called the **Attribute Browser**. There is no **OK** button; changes are updated immediately. More precisely, changes to toggle buttons, combo boxes (i.e. menus) and color pickers are immediate. Changes to single line edit boxes are updated when either “Enter” is hit on the keyboard or the edit box loses the input focus, i.e. you click outside the box. The only difference for multiline edit boxes is that they use the Enter key for new line insertion, so hitting it does not update the value.

The object selection for the attribute browser works as follows. The context menu access to **Attributes**, **Preferences**, and the **Model Browser** works. Furthermore, simply selecting an object or inserting, dropping or pasting it selects that object for the Attribute browser. If more than one object is selected – in the **Model Browser** or in the **Model Editor** - the attribute browser will allow only the common attributes of these objects.

At the top of the dialog there are three tabs, one for the attributes one for the preferences and another for the properties. Note that the Attribute Browser window, just like the Model Browser window, is dockable; it can float as an independent window or it can be docked to any side of the GME Main window.

4.4. The Model Browser

As mentioned earlier, the GME is a configurable graphical editing environment. It is configured to work within a particular modeling paradigm via a *paradigm definition file*. Paradigm definition files are XML files that use a particular, GME specific Document Type Definition (DTD). Models cannot be created and edited until a paradigm definition file (or its compiled, binary version with *.mta* extension) has been opened.

Once a project has been loaded, the GME opens a **Model Browser window**. The **Model Browser** is primarily used to organize the individual models that make up an overall project, while the graphical editor is used for actually constructing the project's individual models.

Figure 5. Model Browser showing folders and models.

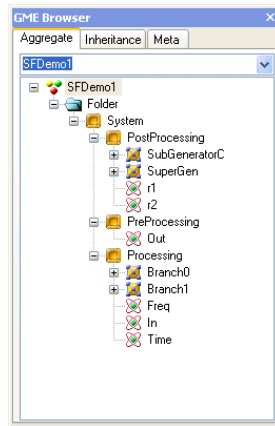

The most important high-level features of the **Model Browser** are accessible through the three tabs displayed at the top of the **Model Browser**. These tabs deal with the **Aggregate**, **Inheritance**, and **Meta** hierarchies.

The **Aggregate** tab contains a tree-based containment hierarchy of all folders, models, and parts from the highest level of the project, the Root Folder. The aggregate hierarchy is ignorant to aspects, and is capable of displaying objects of any kind. More information on the aggregate hierarchy will be provided shortly.

Figure 6. Model Browser with each tab selected

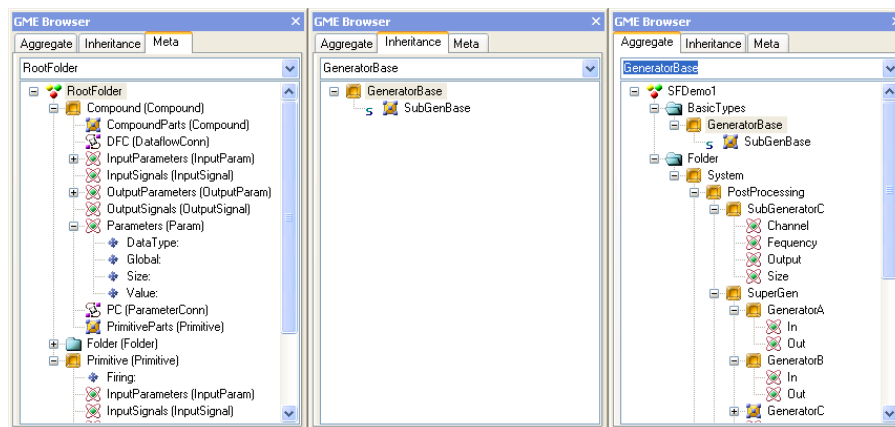

The **Inheritance** tab is used explicitly for visualizing the type inheritance hierarchy (described in detail later). It is entirely driven by the current model selection within the aggregate tree. For example, the current

selection in the aggregate tree in the figure above is a model "GeneratorBase". It has one subtype, called "SubGenBase", and two instances, bearing the name "GeneratorA" and "GeneratorB". This type/instance relationship is shown in the Inheritance tab. We also have an instance model of the "SubGenBase" subtype, called "SubGenBase". In the **Aggregate** tab the letter "S" denotes a subtype, while a letter "I" can be found in front of instances.

The **Meta** tab shows the modeling language at a glance: it displays the legally available array of Folders and objects that can be added at any level within the aggregate hierarchy. For example, at the "Root Folder" level we can add "Folder" folders. Within these folders, we can add models Primitive and Compound. From these models, more parts can be added.

4.4.1. Model Browser navigation

Arrow keys can navigate the selection in vertical directions. The [Backspace] key moves the selection to the parent object. The [Delete] key allow for deletion of the current selection. Object name editing is achieved through delayed clicking on an object's name. Multiple selection is achieved through [Shift] or [Control] clicks. Incremental searching is offered for all three tabs through the text entry field immediately below the **Aggregate**, **Inheritance**, and **Meta** tab selections. The search is limited to the currently expanded section of the tree to avoid time-consuming search in a potentially large database. If a global search is desired, pressing the [Asterisk] key when the root folder is selected fully expands the tree and the search becomes project-wide.

Most hidden functionality offered within the GME **Browser** is available through contextual menus and drag and drop operations. Currently contextual menus are only offered for selections found within the **Aggregate** tab. Contextual information is primarily used for easily inserting new objects based on the current selection, or for capturing the contents of current selections for **Edit** functions (**Copy**, **Paste**, **Delete**, etc.).

Figure 7. Model Browser context menus

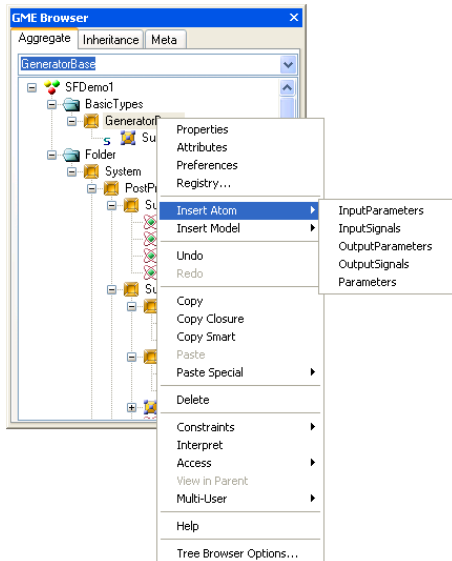

Based on the **Aggregate** tab selection shown above, five different kinds of atoms are available for insertion (Models can also be inserted, but within this Model we have specified that the paradigm not allow any References or Sets). Note that connections cannot be added using the **Browser**.

Similarly, several **Edit** options are available in the form of **Undo**, **Redo**, **Copy**, **Paste**, etc. Sorting options allow for the all of the objects and their children to be sorted by a specific style. The **Tree Browser Options**

menu item displays a dialog used for specifying the types of objects to be displayed in the **Aggregate** tab. For example, the user can choose not to view connections in the browser. To preserve the state of the aggregate tree (eg.:expanded objects) in the Windows registry the checkbox in bottom of the options dialog must be set. **Interpreting**, **Constraint Checking**, and context sensitive **Help** are also available.

Drag and drop is implemented in the standard Windows manner. Multiple selection items may serve as the source for drag and drop. Modifiers are important to note for these operations:

- No modifier: Move operation
- [Ctrl]: Copy (signified by "plus" icon over mouse cursor)
- [Ctrl]+[Shift]: Create reference (signified by link icon over mouse cursor)
- [Alt]: Create Instance (signified by link icon over mouse cursor)
- [Alt]+[Shift]: Create Sub Type (signified by link icon over mouse cursor)

If a drop operation fails, then a dialog will indicate so. Drop operations can occur within the **Browser** itself, allowing this to be an effective means to restructuring a hierarchy. Drop operations can only be performed onto a Model or a Folder.

4.4.2. Model Browser and Interoperation

Double-clicking on any model in the tree (or pressing the [Space] or [Enter] key when a model is selected) will open that model for editing in the graphical model editor. Double-clicking an atom, reference or set, will open up the parent model, select the given object and scroll the model, so that the object becomes visible.

4.5. The Model Editor

4.5.1. The Editing Window

When a model is selected for editing, an **Editor** window opens up to allow editing of that model. The **Editor** window shows the contents of the selected model in one aspect at a time.

Figure 8. A typical model Editor window with an open context menu.

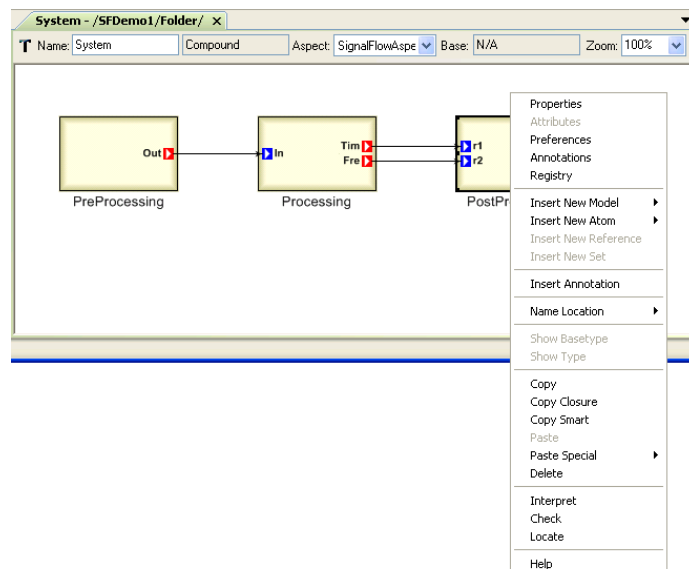

A typical **Editor** window is shown above. The status line near the top begins with an icon indicating whether the current model is a type (T) or instance (I). Next to it is a field indicating the model's name – *System* in this case. Next to the model's name is the *kind* field, indicating the kind of model (e.g. *Connector*, *Compound*, *Network*, etc.) being edited. Continuing to the right, the *Aspect* field indicates that this model is being viewed in the *SignalFlowAspect*. Remember, a model's appearance, included parts, and connection types can change as different aspects are selected. Finally, the right side of the status line shows the base type of this model in case it is a model type (if it is an archetype, it does not have a base type, so the field shows N/A), or the type model in case the current model is an instance.

4.5.2. GME Menus

On the GME Menubar, the following commands are available:

File The **File** menu is context-sensitive, with choices depending on whether or not a paradigm definition file and/or project has been loaded and whether there is at least one **Model Editor** window open. If no **Model Editor** window is open, the following items show:

- **New Project:** Creates a new, empty project and allows registering a new modeling paradigm (discussed in detail later).
- **Open Project:** Opens an existing project from either a database or a binary file with the *.mga* extension (discussed in detail later).
- **Close Project:** Saves and closes the currently open project (if any).
- **Save Project:** Saves the current project to disk.
- **Save Project As:** Saves the current project with a new name.
- **Abort Project:** Aborts all the changes made since last save and closes project.
- **Export XML:** GME uses XML (with a specific DTD) as a export/import file format. This command saves the current project in XML format.
- **Import XML:** Loads a previously exported XML project file. Note that the file must conform to the DTD specifications in the *mga.dtd* file. If no paradigm is loaded, GME tries to locate and load the corresponding paradigm definitions.
- **Update through XML:** Allows updating the current model in case of a paradigm change. If the user has a project open in one GME, while she modifies the metamodels in another GME and regenerates the paradigm, this command allows updating the models by automatically exporting to XML and importing from it. Note that any changes that invalidate the existing models, for example deleting a model kind that has instances in the project, will cause this operation to fail. However, adding new kinds of objects, attributes, etc, or deleting unused concepts will work.
- **Exit:** Closes GME.

If a **Model Editor** window is open, the following options are available:

- **Close Model:** Closes the current **Model Editor** window.
- **Print:** Allows the user to print the contents of the currently active **Model Editor** window. It scales the contents to fit on one page.
- **Print Setup...:** Standard Windows functionality.

- **Print to Metafile**

Tools The **Tools** menu is also context-sensitive. If no project is open, the following items are available:

- **Register Paradigms:** Registers a new modeling paradigm (discussed in detail later).
- **Options:** Sets GME-specific parameters. Currently, the only supported options are to set the path where the icon files are located on the current machine and whether GME should remember the state of the docking windows. For the paths the user can type in a semicolon separated list of directories (the order is significant from left to right), or use the add button in the dialog box to add directories one-by-one utilizing a standard Windows File Dialog box. Icon directories can be set for system-wide use or for the current user only. GME searches first in the user directories followed by the system directories.

AutoRouter related features are configurable here also. The global auto-routing policy can be turned on/off (for more information please check out the section on AutoRouting). You can also set if the AutoRouter should avoid labels with the connection lines or not (the default setting is off). The connection horizontal/vertical snap threshold angle comes to play when you edit fully customizable connections. In that case this angle is used to determine if snapping should be applied or not. You should give the angle in degrees and not in radian. Holding down the control key suppresses the snap algorithm. For further details please check the section on AutoRouting.

In the Miscellaneous group the edge and the font smoothing mode can be controlled distinctively besides many other things.

Figure 9. GME properties, edge and font smoothing options

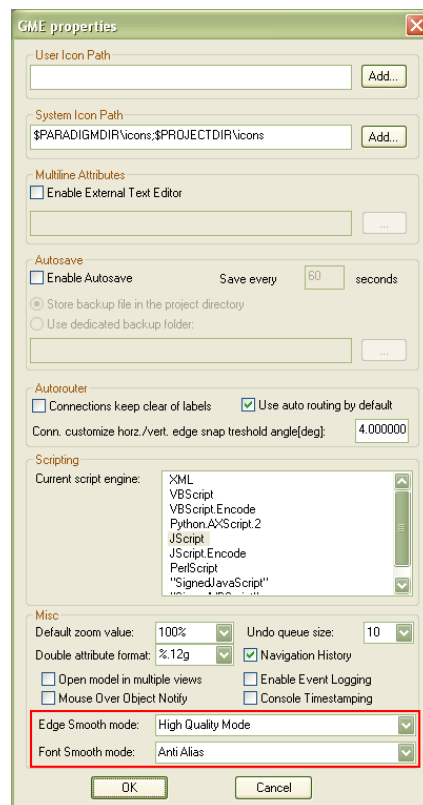

If you find that your monitor displays the lines in a blurry manner, edge/font smoothing (or also called anti-aliasing) can be the source of the problem besides the monitor's settings. If you turn off the anti-aliasing completely, you will have a more crisp outline of curves and fonts, but it can be also not nice to the human eyes. With these setting the choice is upon you.

- **Multi-User | Active Users...**
- **Multi-User | Subversion...**

After a project has been loaded or created, the following menu items are active:

- **Constraints | Check All:** Invokes the Constraint Manager to check all constraints for the entire project.
- **Constraints | Display Constraints:** All the constraints defined in the meta-model are displayed. These constraints can be disabled globally, or on object basis in this dialog. Options of constraints' evaluation are also available.
- **Register Components:** Registers an interpreter DLL with the current paradigm. A dialog box appears that makes it possible to register as many interpreters as the user wishes.
- **Multi-User | Refresh SourceControl Status...**
- **Multi-User | Show Owner...**

Once a **Model Editor** window is open, the following additional items become available:

- **Run Interpreter:** As mentioned earlier, model interpreters are used in the GME to extract semantic information from the models. This menu choice invokes the model interpreter registered with the paradigm using the currently selected model as an argument. Depending on the specific paradigm and interpreter, such an argument may or may not be necessary. A submenu makes it possible to select an interpreter if there is more than one interpreter available.
- **Run Plug-Ins:** Plug-ins are paradigm independent interpreters. This command makes it possible to run the desired one.
- **Constraints | Check:** Invokes the Constraint Manager to check the constraints for the current model.

After a project has been loaded or created, the following menu items are active:

- Edit
- **Undo, Redo:** The last ten operations can be undone and redone. These operations are project-based, not model/window-based! The Browser, Editor, and interpreters share the same undo/redo queue.
 - **Clear Undo Queue:** Models that can be potentially involved in an undo/redo operation are locked in the database (in case of a database backend, as opposed to the binary file format), so that no other user can have write access to them. This command empties the undo queue and clears the locks on object that are otherwise not open in the current GME instance.
 - **Find:** Find model elements. This menu item is discussed in detail in Section 4.12, "Searching Objects".
 - **Project Properties:** This command displays a dialog box that makes it possible to edit/view the properties of the current project. These properties include its name, author, creation and

last modification date and time, and notes. The creation and modification time stamps are read-only and are automatically set by GME.

Items available only when a model Editor window is open:

- **Show Parent:** Active when the current model is contained inside another model. Selecting this option opens the parent model in a new editing window.
- **Show Basetype:** Active when the current model is a type model but not an archetype (i.e. it is not a root node in the type inheritance hierarchy). This command opens the base type model of the current model in an editing window.
- **Show Type:** Active when the current model is an instance model. This command opens the type model of the current model in an editing window.
- **Copy, Paste, Delete, Select All:** Standard Windows operations.
- **Paste Special:** A submenu makes it possible to paste the current clipboard data as a reference, subtype or instance. Paste Special only works if the data source is the current project and the current GME instance.
- **Delete:** Removes the selected model element(s)
- **Cancel:** Used to cancel a pending connect/disconnect operation.
- **Clear Console:** Empties the GME console
- **Preferences:** Shows the preferences available for the current model (see detailed discussion in a separate section below).
- **Annotations:** Shows the **Annotations** dialog.
- **Registry:** The registry is a property extension mechanism: any object can contain an arbitrarily deep tree structure of simple key-value pairs of data. Selecting this menu item opens up a simple dialog box where the current object's registry can be edited. Special care must be taken when editing the registry, since it is being used by the GME GUI to store visualization information and domain-specific interpreters may use it too.
- **Synch Aspects:** The layout of objects in an aspect is independent of other aspects. However, using this functionality, the layout in one source aspect can be propagated to multiple destination aspects. A dialog box enables the selection of the source and destination aspects. The objects that participate in this operation can also be controlled here. The default selection is all the visible objects in the source aspect if none of them were selected in the editing window, otherwise, only the selected ones. Two check boxes control the order in which objects are moved. This is important in case objects compete for the same real estate. Priority can be given to the selected objects and within the selected objects the ones that are visible in the source aspect.
- **Reset Stick Settings**

View	Allows the toggling on and off of the Toolbar, the Status Bar (bottom of the main window), the Browser window, the Attribute Browser, and the Part Browser window.
Window	Cascade, Tile, Arrange Icons: Standard Windows window management functions.
Help	• Contents: Accesses the ISIS web server and shows the contents page of this document.

- **Help:** Shows context-sensitive, user-defined help (if available) or defaults to the appropriate page of this document. See details in a subsequent section.
- **About:** Standard Windows functionality.

4.6. Annotations

GME provides annotations for attaching notes to your models. These multi-line textual annotations are paradigm independent and available in all of your models.

Annotations are not aligned to the model grid (as opposed to real modeling entities), and they can overlap each other, but they are always lower in the Z-order than normal objects. Like every model contained artifact, the visibility and position of annotations are aspect dependent.

4.6.1. Creating Annotations

You can create a new annotation in an opened model from the context menu **Insert Annotation** if you right-click on an empty area in the model. GME generates a name for your annotation, and normally there is no need to modify this. It also opens the **Annotations** dialog where you can customize the text and appearance of your comment.

4.6.2. Editing Annotations

There are several methods for editing your annotations. You can open the **Annotations** dialog from the main menu bar **Edit | Annotations** or from the context menu **Annotations**.

Figure 10. Annotation editor

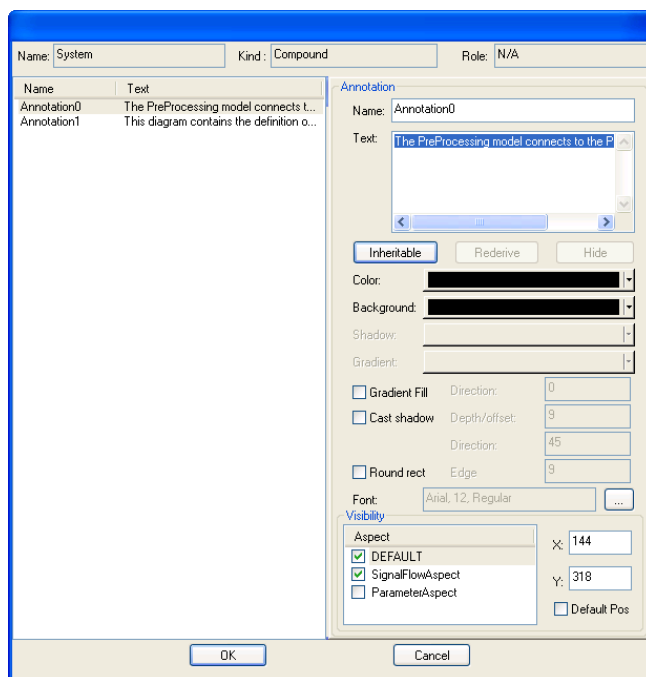

On the left side of the dialog in the figure above all the annotations in the active model are available. On the right-hand side panel you can customize the selected commentary. The **Name**, **Text**, **Color**, **Background**

and **Font** settings are self-explanatory. The **Visibility** sub-panel enables you to fine tune the position and visibility in an aspect based manner. All the aspects of the active model (and a special DEFAULT aspect) are listed on the left side. The checkboxes represent the visibility information in the proper aspect (if an annotation is visible in the DEFAULT aspect, it is visible in all the others, so in this case the other checkboxes are irrelevant.) In the X and Y input boxes you can specify the position of your annotation in a specific aspect (or the default position.) You can also clear (and set to default) the position with setting the **Default Pos** check-box.

4.6.3. Implementation issues

Annotations are stored in the registry of the model. All the registry keys and explanation of them can be found in the table below. The visualization of annotations is handled by custom decorator COM objects (`Mga.Decorator.Annotator`), which use the very same infrastructure as other custom drawing objects.

Table 1.

Registry Key	Description
/annotations	This is the root registry key for annotations
/annotations/<AnnotationName>	The value of this key is the text of the comment
/annotations/<AnnotationName>/color	This key stores the text color of the comment as a 24 bit hexadecimal number
/annotations/<AnnotationName>/bgcolor	This key stores the background color of the comment as a 24 bit hexadecimal number
/annotations/<AnnotationName>/font	The encoded form of the specified font (Win32 LOGFONT structure)
/annotations/<AnnotationName>/aspects	The key stores the default position of the annotation
/annotations/<AnnotationName>/aspects/*	If this key is defined the annotation is visible in all aspects
/annotations/<AnnotationName>/aspects/<AspectName>	If defined, the annotation is visible in the specific aspect. If it contains a position code, this will be the position of your comment in this aspect.

4.7. Managing Paradigms

The **Register Paradigm** item in the **Tools** menu displays a dialog box where the user can add or modify paradigms. This dialog box is also displayed as the first step of the **New Project** command (see below).

Like other items recorded in the Windows registry, paradigms can be registered either in the current user's own registry [`HKEY_CURRENT_USER/Software/GME/Paradigms`] or in the common system registry [`HKEY_LOCAL_MACHINE/Software/GME/Paradigms`]. If a paradigm is registered in both registries, the per-user registry takes precedence. When changing the registration of paradigms it can be specified where the changes are to be recorded. Non-administrator users on Windows systems generally do not have write access to the system registry, so they can only change the per-user registration.

Paradigms are listed by their name, status, connection string and current version ID. The name is what primarily identifies the paradigm. The status is 'u' (user) or 's' (system) depending where the paradigm is registered. The connection string specifies the database access information or the file name in case of binary files. Version ID is the ID of the current generation of the paradigm.

The registry access mode is selectable in the lower right corner of the dialog box.

Pressing the **Add from file...** button displays a file dialog where the user can select compiled binary files (.mta) or XML documents. It is possible to store paradigm information in MS Repository as well. The **Add from DB...** button is used to specify paradigms stored in a database, like MS Access.

If the new paradigm specified was not yet registered, it will be added to the list of paradigms. If, however, the paradigm is an update to an existing paradigm, it will replace the existing one, but the old paradigm is also kept as a previous generation. (The only exception is when the paradigms are specified in their binary format (i.e. not XML) and the file or connection name of the new generation corresponds to that of the previous one.) This way existing models can still be opened with the legacy paradigms they were created with. For new models, however, the current generation is used always.

Paradigms can be unregistered using the **Remove** button. Note that the paradigm file is not deleted.

Different generations of an existing paradigm can be managed using the **Purge/Select** button. This brings up another dialog showing all the generations of the selected paradigm. One option is to set the current generation, the one used for creating new models. The other option allows unregistering or also physically deleting one or several of the previous generations. (Whether the files are deleted is controlled by the checkbox in the lower right corner.)

Important

New paradigm versions are not always compatible with existing binary models. If a model is reopened, GME offers the option to upgrade it to the new paradigm. If the upgrade fails, XML export and re-import is needed (the previous generation of the paradigm is to be used for export). XML is usually the more robust technique for model migration; it only fails if the changes in the paradigm make the model invalid. In such a situation the paradigm should be temporarily reverted to support the existing model, edited to eliminate the inconsistencies, and then reopened with the final version of the paradigm.

4.7.1. New Project

Selecting the **New Project** item in the **File** menu displays the dialog box described in the previous section. All the features mentioned are available, plus an additional button, **Create New...** which is used to proceed with the creation of a new project.

Once the desired paradigm is selected, pressing the **OK** button displays another small dialog where the user can specify whether to store the new project in MS Repository or a binary file. Pressing **OK** creates and opens a new blank project. At this point, the only object available in the project is the root folder shown in the **Model Browser**. Using the context menu (right-clicking the **Project Name**), the user can add folders and other objects, as defined in the paradigm. Double-clicking a model opens it up in a new **Editor** window.

4.8. Editor Operations

Using the **Editor** window the user can edit the models graphically. Menus and editing operations are context sensitive, preventing illegal model construction operations. (Note, however, that even a syntactically correct model can be invalid semantically!) This section gives a brief overview of common editor operations, such as changing editing modes, creating and destroying models, placing parts, etc.

4.8.1. Editing Modes

The graphical editor has six editing modes – **Normal**, **Add Connection**, **Delete Connection**, **Set Mode**, **Zoom Mode** and **Visualization**. The **Editing Modebar**, located (by default) just to the left of the main editing window, is used to change between these modes.

Figure 11. GME Editing Mode Bar

The figure above indicates the buttons used to select different editing modes. The **Editing Modebar** is a *dockable* Windows menu button bar. It can be dragged to different positions in the editor, floated on top of the editing window, or docked to the side of the editor.

4.8.1.1. Normal Mode

Normal mode is used to add/delete/move/copy parts within editing windows. Models (from the **Model Browser**) and parts (from the **Part Browser**) may be copied by left-click-dragging the objects into the **Editor** window. Standard Windows keyboard shortcuts ([Ctrl-C] to **Copy**, [Ctrl-V] to **Paste**) may also be used. A copy operation (the default when dragging from the **Part Browser**) is indicated by the small “+” symbol attached to the mouse cursor during the left-click-drag operation.

Parts and models may be moved and/or copied between models, too. Here, the normal left-click-dragging operation causes a *move* operation instead of a copy. To copy parts and models between or within models, hold down the [Ctrl] key before dropping.

New parts and models are given a default name (defined in the modeling paradigm). Right-clicking a part (even connection) brings up a context menu. Choose Properties to edit/view an object's properties. Choose Attributes to edit its paradigm-specific attribute values.

As mentioned earlier, reference parts act as pointers to objects, providing a *reference* to that part or model. References are created by holding down [Ctrl-Shift] while dropping parts into a new model from another model window or from the **Browser**. When dragging a reference from the **Part Browser** it is not necessary to hold down any keys because the source already specifies that a reference is to be created. In this case, however, a null reference is created since there is no target object specified (similar to using the context menu to insert a reference).

References can be redirected, i.e. the object they refer to can be changed. Simply drop an object on top of an existing reference, and if the object kind matches, the reference is redirected. Note that the type hierarchy places restrictions on this operation as well (see later in the Type Inheritance chapter).

Subtypes and instances of models can be created by holding down [Alt-Shift] and [Alt] keys respectively during the drop operation. Type inheritance is described in a separate chapter.

Parts and models may be removed by left-clicking to highlight them, and either selecting **Delete** from the **Edit** menu, or by pressing the [Delete] key. Note that any connections attached to an object will also be deleted when that part or model is deleted. Also remember that parts can only be deleted after all references to them have already been deleted.

4.8.1.2. Add Connection Mode

This mode allows connections to be made between modeling objects. Connections may exist between two atomic parts, between two model ports (think of these as connection points on models), or between an atomic part and a model port. Remember, however, that connections are a paradigm-specific notion and will only be allowed between objects specified by the paradigm definition file as being allowed to be connected together.

Remember that connections are inherently directional in nature. Connections are made by first placing the editor in the **Add Connection Mode**, then left-clicking the source object, followed by left-clicking on the destination object.

It is not necessary to go to this mode to create a connection. Instead, in **Edit** mode right clicking on the desired source of a new connection and selecting **Connect** in the context menu changes the cursor to the connect cursor. A connection will be made to the object that is left clicked next. (Or by selecting the **Connect** command on the destination object as well.) Note that any other operation, such as mode change, window change, new object creation, cancels the instant connection operation.

4.8.1.3. Remove Connection Mode

By placing the graphical editor in the **Remove Connection Mode**, connections between objects can be removed by simply left-clicking on the connection itself or the source and/or destination parts.

4.8.1.4. Set Mode

Set parts are added to a model just like any other part. However, their members can only be specified when the editor is in **Set Mode**. Once the editor is in this mode, right-clicking a set will cause all parts (even connections) in the model that are not part of the given set to be “grayed out.” Left-clicking object toggles their membership in the set. As they are added/removed to the set, they regain/lose their color and appearance.

4.8.1.5. Zoom Mode

The **Zoom Mode** allows the user the view the models at different levels of magnification. The supported range is between 10% and 300%. Left clicking anywhere in a model window zooms in, while right-clicking zooms out. The zoom level is window-specific.

4.8.1.6. Visualization Mode

The **Visualization Mode** allows single objects and collections of objects (“neighborhoods” of objects) to be visually highlighted with respect to other modeling objects. This is useful when examining and/or discussing complex models.

To enter the **Visualization Mode**, select the **Visualization Mode** button on the GME editing mode bar (see picture above). This will cause all visible parts and connections to become “grayed out.” Next, the user may click on objects using either the left or right mouse buttons to make them fully visible again. Left- and right- clicking have different effects, as described below.

Left-clicking on any part toggles the visibility of the object. For connections, their source and destination objects are toggled. The user may continue to select parts in this manner, highlighting/hiding more and more objects. Right-clicking on a part will toggle the visibility of the object and the objects at the ends of its connections. Note that exactly those connections are highlighted at any one time that connect highlighted objects.

4.8.1.7. Miscellaneous operations

The following operations are only accessible from the toolbar:

- **Toggle grid:** At zoom levels 100% or higher a grid can be displayed in the model editor window. GME objects always snap to this fine grid, whether they are visible or not, to facilitate alignment of the objects.
- **Refresh:** Clicking the paintbrush button forces GME to repaint all the windows.

In the current model **Edit** window, there is a selected list of objects highlighted by little frames. Using the Arrow keys on the keyboard, these objects can be moved by one grid cell in the selected direction, provided that there are no collisions. Note that GME does not allow overlapping objects.

Connections in GME are automatically routed. The user only needs to specify the end points of a connection and an appropriate route will be automatically generated that will avoid all objects and try to provide a visually pleasing connection layout.

The built-in context-sensitive help functionality is described in the next section.

4.9. AutoRouter Features

The AutoRouter determines a connection's position between model elements. However, sometimes the user wishes to specify the position. Connection line customization features fulfill two fundamental needs:

- The auto routed connection lines can be customized: line segments (edges) can be dragged within the possible limits. At the same time, the logic of the system is still preserved.
- The whole auto routing logic can be turned off for connections individually or completely for a model (on global level or FCO model level). You are allowed to freely edit the whole connection.

The techniques can be also mixed, so some of the connection lines can be maintained by the auto router logic system, while the others can be completely free from it.

4.9.1. Autorouting policy

The user can specify if certain connections should be routed automatically or manually on three possible levels (this is also the order of priority):

- For connections individually
- At the parent model level
- GME's global options

4.9.1.1. GME's default routing policy

If a connection doesn't have a setting on the connection or parent level, GME's default routing policy determines how the connection should be treated. With model level and global settings, it possible to fully customize every connection in a model (fulfilling the second need). You can turn off the default auto routing in the “**Tools | Options...**” menu “**Autorouter**” group's first checkbox (see Figure 12, “GME AutoRouting default”). Just as other settings in this dialog, this setting is stored in the Windows registry, and it is valid for the current installation of GME and the current user. If the model is transferred to another machine, the same settings should be applied to the other GME.

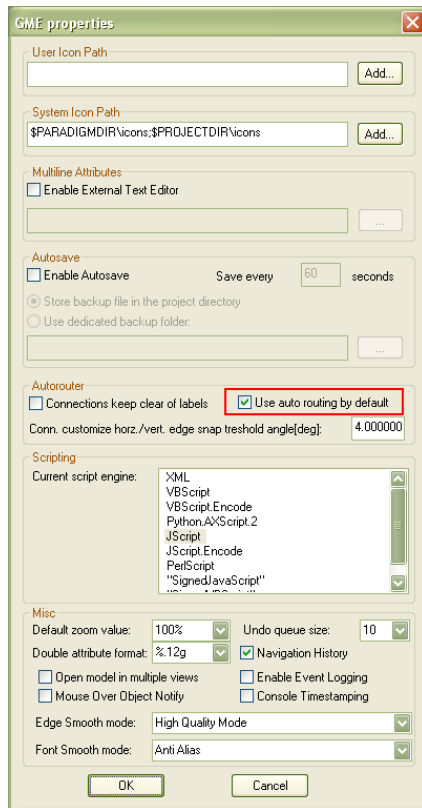
Figure 12. GME AutoRouting default

By default, the auto routing is turned off and the model and connection entities don't contain any directive about auto routing, so everything should work exactly the same way as with the older GME versions. You can exclude certain connections from the auto-routing with the use of the **Attribute Browser** or the context menu. In this case a registry value is added to the connection entity node, and the auto routing logic no longer will take care of the connection.

If somebody turns off the default auto routing policy, and the model doesn't contain specific policies for connections, all of the routes will be fully customizable. Turning off the autorouting settings on GME's global level or model level indicate an automatic conversion routine, which takes the auto routed points and loads these calculated points as custom points into connection's customization data. As a result, after the conversion you won't just have a simple line which connects the start point and the end point, but the customization operation can be started from a state where a similar topology to the autorouted scheme is present.

4.9.1.2. Switching routing policy on per connection basis

The user can exclude certain connections from the auto-routing by setting the "Is auto routed" property in the **Attribute Browser's Preferences** page to `false`. In this case the auto routing logic no longer will take care of the connection; it won't see this connection at all. Similarly, if the value `true` is set, the particular connection will join the auto-routing scheme again. Switching back and forth between the settings will preserve the customization data for both types of routings. Hitting `Ctrl+D` clears the preferences settings.

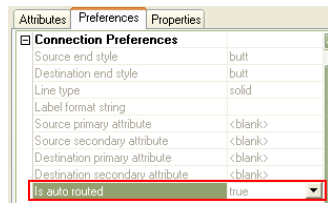
Figure 13. Connection AutoRouting settings

If the user turns off the default auto routing policy, and the model doesn't contain specific policies for connections, all of the routes will be fully customizable. If there isn't any stored customization data, the previously mentioned conversion routine will store the auto routed path points as the manual connection path points.

4.9.1.3. Switching routing policy on per model basis

On the model's **Preferences** page in **Attribute Browser**, you can find a setting similar to individual connections, but it is under the Auto Router Preferences group in that case.

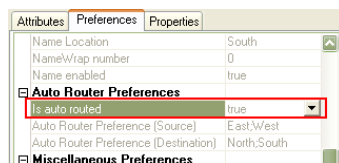
Figure 14. Model AutoRouting settings

This is the highest precedence level preference, so it overrides the per model basis settings and the global GME settings.

4.9.1.4. Auto routed connection

The customization information (which specifies or modifies a certain topology) remains valid until the number of edges that make up the connection line changes, or if a box collision situation emerges as a result of the customization. In these cases, the customization data will be ignored, but not deleted.

4.9.2. Editing a Connection

If you hover over a selected auto-routed connection, the cursor will turn to a vertical or horizontal arrow. With a drag and drop operation, you can adjust the vertical position of a horizontal edge or the horizontal position of a vertical edge. If you hover over a joint of an auto-routed connection, you can initiate a customization operation where both edges which are adjacent to the particular point will be moved.

If a connection line is selected, the edges that have customization information will appear with a dash-dot-dot pattern.

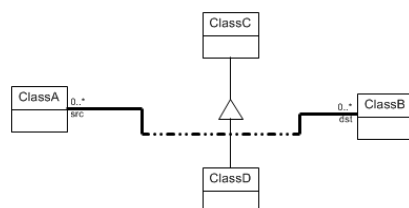
Figure 15. Customized edge with dash-dot-dot pattern

In the context menu, there's also the possibility to delete the customization for just a given edge, or delete all customization of the connection for the actual aspect. Also you can delete all customization data for all aspect for the particular connection using the proper context menu point.

Figure 16. Context menu with options to delete customization

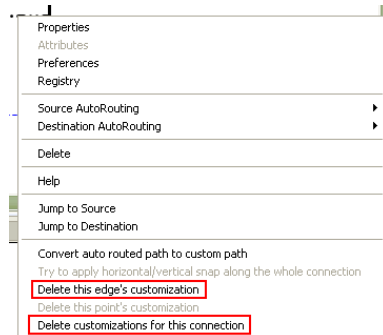

4.9.3. Fully customizable connection modifications

The skew connection edges totally get out of control of the auto router algorithm. The vertical and horizontal edges of the path are still taken into account during the auto routing algorithm, so they won't collide with auto routed lines. There's no box avoidance logic; it is totally up to you how you want to route the connection line. The only logic which still applies determines the start and the end point according to the box's router direction preferences.

4.9.3.1. Editing fully customizable connections

You can click on a point anywhere on an edge on a connection, and with a drag and drop technique a new point can be added to the route.

Figure 17. Creating a skew connection

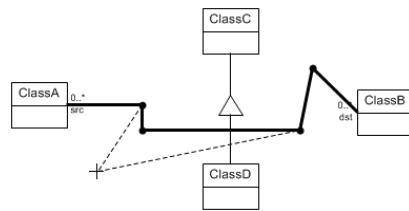

You can repeat this as many times as required and add other points. Removing points can be done with context menu (right clicking on the desired point) or by simply moving the point in-line with the adjacent points. If you move the point in-line with the adjacent points, the point will be automatically removed from the route.

Besides automatic point deletion, There's also a logic which does horizontal and vertical alignment of connection edge. This means that if a newly added point creates a nearly vertical or nearly horizontal edge, GME will automatically adjust those to be totally vertical/horizontal. The align algorithm can be disabled by holding down the Ctrl (Control) button during the point addition drag and drop process. Also you can run this alignment algorithm along the whole connection using the "**Try to apply horizontal/vertical snap along the whole connection**" context menu item.

You can tune the most important parameter of the logic (the snap treshold angle) into the Tools Options dialog. You should give the angle in degrees (and not in radian). See the previous screenshot of the dialog in this section.

Figure 18. Connection customization horizontal/vertical edge snap threshold value settings

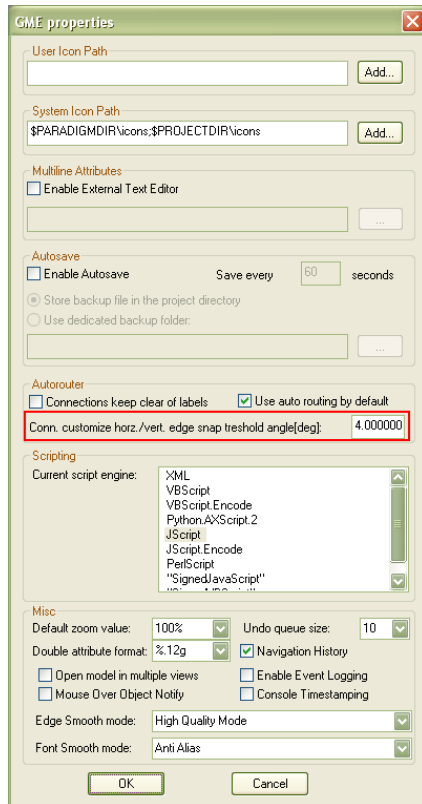

GME tries to obtain the data of an auto-routed connection path and feed that edge information into the fully customizable path's data. That work is done by a special algorithm: it converts the route determined by the auto-router logic into a series of fully customizable connection points. This way you can start to customize an existing line and do not have to build up one from scratch. This algorithm runs before you change the auto routing state of the GME application, on a whole model or an individual connection. Note that this algorithm needs to run the auto-routing algorithm on the whole model to be able to obtain the needed information, so it might make opening or refreshing of a model view slower. For example if you modify the auto-routing state of a sub-model and you open that sub-model in a view much later, the conversion algorithm will run only at the time (during the view opening procedure).

The start and the end points of the connections are special: they are still determined by the auto-routing logic. This is partly because connection path ending in a port wouldn't be movable anyway because the location of the port cannot be changed inside the model box (the port position is automatically computed and fixed).

4.10. Emergency saves and GME CrashDumps

GME is able to generate a *CrashDump* in the event of a GME crash. A *CrashDump* file (a Microsoft MiniDump crash report file with additional custom information stream) contains a collection of information related to the particular crash. With the help of this file, developers have information to analyze the crash and discover the bug more easily. The file has a *dmp* extension and named after the precise date and time (GMT) of the crash event and the process Id and thread Id of GME. This should result in a unique name of the form: "GME_CrashDump-yyyy-mm-dd_(hh-mm-ss)_pid_tid.dmp", for example: "GME_CrashDump-2009-10-01_(16-09-56)_3180_4828.dmp".

In case of a crash event GME first presents a dialog about the crashdump. After that another dialog is presented about the project emergency save.

Because parts of memory can contain classified information, there's a choice to not generate the CrashDump. This security reason is the only one why we don't automatically save a report and collect them on a central server at ISIS. If the report is generated, it will reside on the user's machine and it's up to the user to send it to the developers. It can be found "%OSDir%\Documents and Settings\%UserName%\Application Data\GME\" folder on Windows XP or "%OSDir%\Users\%UserName%\AppData\Roaming\GME\" folder on Windows Vista or Windows 7. Please open the folder and attach the file to the e-mail to the mentioned e-mail address (see next paragraph or the crashdump dialog).

Figure 19. Crashdump dialog

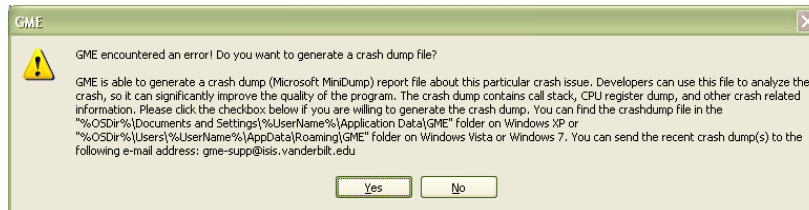

If your security policy allows sending such information to the developers, please select "Yes" to generate the crashdump, then send it to gme-supp@isis.vanderbilt.edu as a file attachment. If you have any trouble handling crashdumps, you can also send e-mail to the [gme-users](#) mailing list, and the developers will help you.

There are two types of Emergency save dialogs:

- **Figure 20. Emergency save dialog when a single-user project is open**



- **Figure 21. Emergency save dialog when a multi-user project is open**

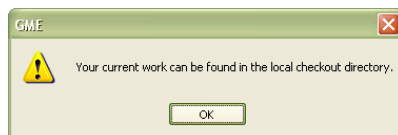

Note, that if there isn't any open project at the time of the crash, then no additional dialog is displayed after the crashdump dialog.

4.11. Help System

GME provides context-sensitive, user-defined help functionality. This is facilitated by the "Help URL" preference of objects. This preference is inherited from the paradigm definition and through the type inheritance hierarchy exactly like any other object preference. For more information on this inheritance, see the separate chapter on type inheritance.

When the user selects help on a context menu or the **Help** menu item for the current model (also the [F1] key), GME looks up the most specific help URL available for the given object. If no help URL is found, the program defaults to the appropriate section of the User's Manual located on the ISIS web server.

When the appropriate URL is located, GME invokes the default web browser on the current machine and displays the contents of the URL. If no network connection is available, the help system will be unable to display the information unless the web server is running on the current machine or the URL refers to a local file.

4.12. Searching Objects

Search in GME is implemented as a dockable window. Now you can dock the search window wherever you like. The **Search** window can be opened by executing the **Edit | Find** command, using the [CTRL-F] shortcut, or clicking the binocular icon in the toolbar. The search window is tabbed along side console.

Figure 22. GME Search Window

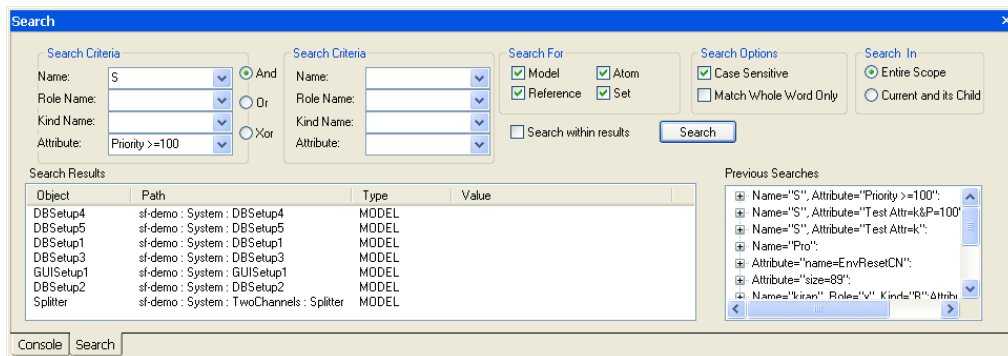

4.12.1. Search Criteria

The search in GME has two search criteria. Each search criteria takes *Name*, *Role Name*, *Kind Name* and *Attribute*. Each of these inputs is treated as a regular expression. An object must match all of the inputs to be considered a match. For example, if you specify both Name and Role Name in first search criteria, then both of them must match for a given object to be included in the search result. The purpose of each input is as follows:

- Name** used to specify the name of the object. The Search checks for any names that match the pattern specified by this field
- Role Name** used to specify the role name of the object. The Search checks for any role names that match the pattern specified by this field.
- Kind Name** used to specify the kind name of the object. The Search checks for any kind names that match the pattern specified by this field.
- Attribute** used to specify an attribute appearing in the object. This field can take complicated logical expressions as input. An attribute has a value associated with it. You can search for attributes with a specific value or a value satisfying an expression.

Supported operators in attribute expression:

- Logical Operators: & (AND), | (OR)
- Comparison Operators: =, >, <, >=, <=, !=

Attribute expressions can be combined with logical expressions. For example, let's say you want to search a person object with `age > 18` and `height less than 6 feet`. Then you can have an attribute expression like this: `age > 18 & height < 6`. This will find all

objects which have attribute called age and height, and then compare the values of those attributes. In this case it checks if the age is greater than 18 and height is less than 6.

Note

>, <, >= and <= are not valid for string attribute types.

The two search criteria are combined with logical operators. The operators are given below:

And Matching objects must satisfy both the search criteria.

Or Matching objects must satisfy at least one of the search criteria.

Xor Matching objects must satisfy exactly one of the search criteria.

4.12.2. Regular Expressions

The *Name*, *Role*, *Kind* and *Attribute* fields can be specified using the regular expressions. This section documents the valid input kinds that the Search tool shall accept.

Note

Regular expressions are case-sensitive.

Note

Check the Match Whole Word Only if you don't want a Regular Expression based search for the first four fields.

Syntax of the expressions:

- Any permutation of characters, numbers & symbols such as “_”, “-” is valid. A few special symbols that are used are “.”, “*”, “+”, “(”, “)”, “[”, “]”, “^”, “\$”.
- The regular expression should be well formed, i.e. all the opening brackets should have corresponding closing brackets.
- Writing “GME” will mean all the string containing the letters “GME” will be returned.
- Writing “GME*” will return all strings containing “GM”, “GME”, “GMEE”, “GMEEE” and so on.
- Writing “GME+” is the same as “GME*” except it doesn't match “GM”.
- Writing “GME.*” is the same as “GME”.

Note

For more information on regular expressions, see <http://www.regular-expressions.info> [<http://www.regular-expressions.info/>].

4.12.3. Search Scope

Search can have one of two scopes indicated by **Search In** Option. **Entire Scope** is the default selection which means all the model hierarchy is searched starting from the root folder. Selection of **Current and Child** requires that some model or folder be selected in the GME Browser. This option will search

the model hierarchy starting from the selected elements. That means only its child elements and their descendants will be searched.

The scope of the search can also be limited to the current search results. In this case only the elements in the current search results are searched. This can be useful when you want to filter out some of the results from current search result. This option is enabled by checking the **Search within results** option.

4.12.4. Object Types

GME has different object types. The types of object to be searched can be designated in **Search For** options group. You can restrict your search to a *Model*, *Atom*, *Set*, *Reference*, *Connection* or a combination of them. Also included is a special type of search for NULL references or references to a particular object. When you check the **Special** checkbox, other checkboxes in the group will be disabled. When you hit search, it will start looking for NULL references in the given scope satisfying the given criteria. Clicking on the object in the result list will set it as the new object whose references are to be searched for. After you click an object in the results and do **Special Search**, the particular object's references will be looked for.

4.12.5. Case Sensitivity and Whole Word Matching

Search can be made case sensitive by checking **Case Sensitive** check box in Search Options. If whole word matching is desired **Match Whole Word Only** can also be checked.

4.12.6. Search Results

The search results will be displayed in the list box beneath the search criteria. The result will show the object's name along with its type and path. You can double click on a specific object to view it in the **Model Editor**.

4.12.7. Search History

Whenever you search for something, it's likely that you may need to search for the same thing again after some time. Your searches are kept in the Previous Searches tree control. You can double click the entry in the tree control to bring it back to the search criteria input boxes. The search history will also be saved in the registry to preserve your searches across GME sessions. Also, the input combo box controls in the search criteria will contain the search history of that field.

4.13. Scripting in GME

In the bottom part of the console window the user can type in her instructions/programs. The user-preferred scripting language can be set in the **Tools | Settings** menu. The default scripting engine is JScript, however in this document Python script samples will be used (Python.AXScript.2).

Figure 23. Script Engine selection

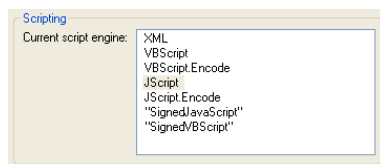

The scripting feature enables the user to automate several operations in the GME world. These may include GUI related operations (i.e. **Export XML**), MGA related model inquires, or modifications operating on the currently opened model.

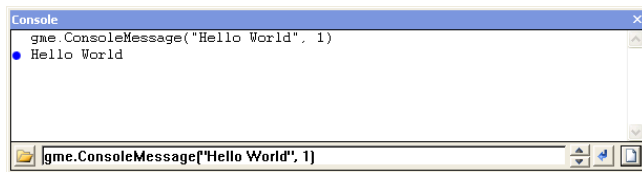
Figure 24. Hello World in GME

Beside the features provided by the selected scripting language (built-in methods, variables or packages) three GME-specific objects are available in the GME scripting environment: `gme`, `project` and `it`.

The first object `gme`, represents the running GME application instance and implements the `IGMEOLEApp` interface as defined in the `Gme.idl` file. This interface allows the user to access various user interface elements of the modeling environment i.e. panels like `ActiveBrowser` and `ObjectBrowser`, or to execute project related commands like: invoking an interpreter on the currently opened model (if any).

```
# hiding the ActiveBrowser window
gme.panels[0].Visible = 0

# check the constraints
gme.CheckAllConstraints()

# invoking an interpreter
gme.RunComponent('Mga.Interpreter.ComponentC')
```

The lifetime of the `gme` object is the same as that of the application. The `project` variable is valid while a project is opened in the main application window. This variable implements the `IMgaProject` interface defined in `Mga.idl`. For accessing the inner elements inside an MGA project transactions must be used.

```
gme.OpenProject('MGA=f:\\sf-sample.mga')
terr = project.CreateTerritory( None, None, None)
project.BeginTransaction( terr )
mf = project.RootFolder.ChildObject('MainFolder')
mf.Name = 'main_folder'
mf.ChildFCO('MainCompound').Name = 'main_compound'
project.CommitTransaction()
gme.CloseProject( 1 )
```

In the code snippet above a sample SF model is opened, the Folder named `MainFolder`, and the *Compound* named `MainCompound` are renamed. Operations accessing the objects inside a project are enclosed in a transaction. In case the transaction commit fails `AbortTransaction` must be used. Beware that during a user-initiated transaction, another transaction should not be started. This means that during scripting, if a transaction has begun, user interface operations (like selection of an object in the **View** or **ActiveBrowser** with the mouse pointer) must be suspended by the user until the transaction is committed or aborted.

The `it` variable represents the currently active model window. It is accessible only while a project is opened, and at least one model window is opened. Should the active model window be closed, the variable will automatically refer to the newly selected active window, if any. The `it` object implements the `IGMEOLEIt` interface (defined in `Gme.idl`). The main benefit of using this object is the ease of use of MGA related operations on a higher level than that offered by the `IMgaObject`, `IMgaFCO` and `IMgaFolder` interfaces (see `Mga.idl`), and it allows the user to automate some repetitive tasks.

The methods `it` provides require either object names, or `IMgaFCO` pointers as incoming parameters, the latter method names being suffixed with “FCO”. The code sample below shows duplicating (clone) of objects:

```
# clones object (if any) named "InSignal", renames the clone to
"ClonedInSignal" and returns it
```

```
clonedInSignalPtr = it.Duplicate( "InSignal", "ClonedInSignal")

# cloning clonedInSignal object 4 times, with different names
for i in range(5): it.DuplicateFCO( clonedInSignalPtr,
    "twiceClonedInSignal" + str(i))

# cloning "twiceClonedInSignal2" object, using the it.Child() method
it.DuplicateFCO( it.Child( "twiceClonedInSignal2"),
    "thriceClonedInSignal")
```

Some other MGA related operations the user may use are: Create, Refer, Include, Connect, ConnectThruPort, SetAttribute, SubType, Instantiate as well as their FCO suffixed counterparts.

The name based Duplicate method requires that "InSignal" must be present in the active model, the pointer based DuplicateFCO method does not enforce this, allowing the clonable object to be in a different model in the same project. Exception to this rule is IncludeFCO requiring that the set object and its to-be-member must be in the same model.

All these operations (i.e. Duplicate, IncludeFCO, Connect etc.) use methods defined in IMgaFCO or IMgaModel interfaces, that require to be executed inside transactions. That is why if no user transaction was active, the method does the duplication or connecting task between BeginTransaction and CommitTransaction calls. If the user initiates this command from a transaction, it is detected and another transaction is not started, and when the method exits the transaction remains open. However, to help users manage transactions, and let them avoid tedious typing (creating territories, passing them to over to BeginTransaction, etc.) simple parameterless BeginTransaction and CommitTransaction methods of the it object are provided.

Connect *and* ConnectFCO methods are used to connect object in one model. Two objects have to be specified (by their name or the pointers) and the connection role may be given optionally. If an empty string is given as connection role, then the object are connected if one possible connection role exists between the source and destination.

ConnectThruPort method is provided to establish connections between ports, referenceports. The connection role again can be left empty. The source and destination are identified by specifying two roles for each. The first one is the name of the container, the second is the name of the port. The container might be a model or a reference. If one port is involved in the intended connection, for example only at the source side, the destination must be specified by leaving the second role parameter empty.

Using ShowFCO method the user can jump to another model, making that the new active model, using a *path* syntax similar to that used on Unix (slashes as delimiters, '..' to step one model up in the hierarchy). The path used must identify uniquely an fco, otherwise the command will not succeed.

The Prev and Next methods can be used to cycle through the already opened models.

PresAspect and NextAspect cycle through the aspects of the current model.

Now console has the ability to load HTML content into the console window if a htm/html extension file is selected with the 'Load Script' dialog. This action won't affect the recent script list, because the HTML content is not a script.

5. Type Inheritance

The type inheritance concepts in GME closely resemble those of object-oriented programming languages. The only significant difference is that in GME, model types are similar in appearance to model instances; they too are graphical, have attributes and contain parts. By default, a model created from scratch is a type. A subtype of a model type can be created by dragging the type and dropping it while pressing the [Alt +Shift] key combination. An instance is created in similar manner, but only the [Alt] key needs to be used.

A subtype or an instance of a model type depends on the type. There is one significant rule that is different for subtypes and instances. New parts are allowed in a subtype, but not in an instance. Otherwise, parts can be renamed, set membership can be changed, and references can be redirected in both subtypes and instances. Parts cannot be deleted and connections cannot be modified in either subtypes or instances.

Any modification of parts in a type propagates down the inheritance hierarchy. For example, if a part is deleted in a type, the same part will be automatically deleted in all of its instances and subtypes and instances of subtypes all the way down the inheritance hierarchy.

Types can contain other types as well as instances as parts. The mixture of aggregation and type inheritance introduces another kind of relationship between objects. This is best illustrated through an example. In the figure below, there are two root type models: the Engine and the Car. The car contains an instance of an engine, V6, and an ABS type model. V6 is an instance of the Engine; this relationship is indicated by the dash line. Aggregation is depicted by solid lines.

Figure 25. Model Dependency Chains

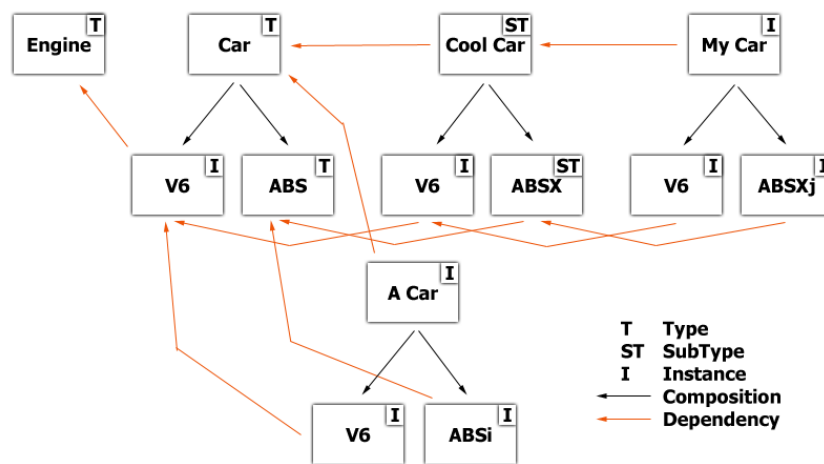

When we create a subtype of the Car (Cool Car above), we indirectly create another instance of the Engine (V6) and a subtype of the ABS type. This is the expected behavior as a subtype without any modification should look exactly like its base type. Notice the arrow that points from V6 in Cool Car to V6 in Car. Both of these are instances, but there is a dependency between the two objects. If we modify V6 in Car, V6 in Cool Car should also be modified automatically for the same reason: if we don't modify Cool Car it should always look like Car itself. The same logic applies if we create an instance of Cool Car (My Car above). It introduces a dependency (among others) between V6 in My Car and V6 in Cool Car. As the figure shows, this forms a dependency chain from V6 in My Car through V6 in Cool car and V6 in Car all the way to the Engine type model.

What happens if we modify V6 in Cool Car by changing an attribute? Should an attribute change in V6 in Car propagate down to V6 in Cool Car and below? No, that attribute has been overridden and the

dependency chain broken with respect to that attribute. However, if the same attribute is changed in V6 in Cool Car, that should propagate down to V6 in My Car unless it has already been overridden there. The same logic applies to preferences.

The figure below shows the same set of models, but only from the pure type inheritance perspective.

Figure 26. Type Inheritance Hierarchy

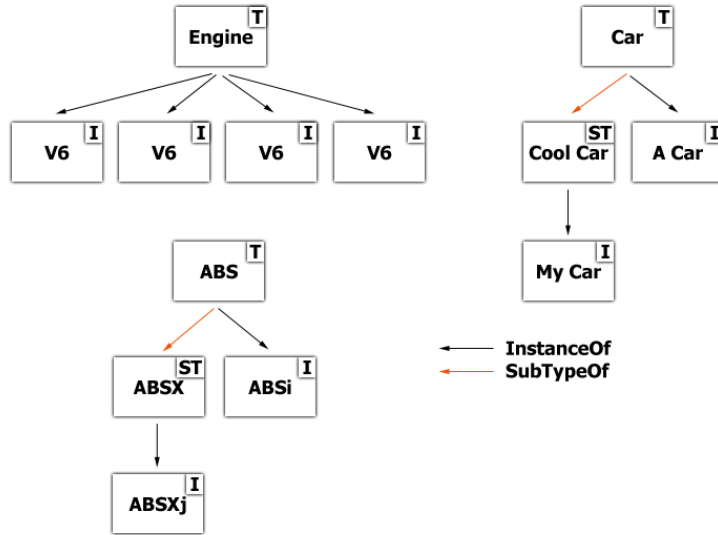

Let's summarize the rules of type inheritance in GME.

- Parts cannot be deleted in subtypes or instances.
- Parts can be added in subtypes only.
- Part changes in a type model propagate down the type inheritance hierarchy unconditionally.
- Aggregation and type inheritance introduce dependency chains between models.
- Attribute and preference changes, set membership modification and reference redirection propagate down the dependency chain. If a particular setting has been overridden in a certain model in the dependency chain, that breaks the chain for that setting. Changes up in the chain do not propagate to the given model or below.
- The rules for reference redirection are as follows. A null reference in a type can be redirected in any way that the paradigm allows down the dependency chain. A reference to a type in a type model can only be redirected to subtypes or instances of the referred-to type or any instances of any its subtypes. A reference to an instance model in a type model cannot be redirected at all down the hierarchy. Obviously, a reference in an archetype can be redirected in any way the paradigm allows.
- To avoid multiple dependency chains between any two objects, in version 1.1 or older, only root type models could be explicitly derived or instantiated. This restriction has been relaxed. Now, if none of a type model's descendants and ascendants are derived or instantiated, then the model can be derived or instantiated. This means, for example, that a model, that has nor subtypes or instances itself, can contain a model type AND its instances. This relaxed restriction still does not introduce multiple dependency chains.

5.1. Attributes and Preferences

The **Attributes** and the **Preferences** tabs each show the items either in gray color or in black color. Items with gray color have the default or inherited value, which means that the value is not given explicitly for this object. If the user assigns a new value to an attribute or preference, the item will be show in black color. An item can be reset to the inherited value by pressing [Ctrl-D] while the item is active.

5.1.1. References and Sets

As mentioned before, references can be redirected (with some restrictions) and set membership can be changed in subtypes and instances. The propagation of settings along the dependency chain is true here too. Changing the settings breaks the dependency chain for the given object. However, the setting can be easily reset by selecting the **Reset** item in the appropriate context menu.

5.1.2. Decorator Enhancements

The default decorator is able to display more information about objects regarding the type inheritance. The user may turn off or on these information in meta-modeling time or modeling time, too.

- On models, "T", "S" or "I" is displayed according to the object type information.
- For instances below the name of the object, the name of the type or subtype is shown with small font.
- The new decorators use vectorial graphics for shapes like: inheritance (triangle), same relationship (diamond), connection bullets, constraint signs, boxes).
- Vectorial shapes and (certain) boxes can have shadows, gradient fills, rounded corners. All of these properties can be defined in meta-models and can be adjusted in the Attribute Browser.
- In-place editing of labels and other text elements, like UML class attributes or meta object attributes.

6. Libraries

GME supports model libraries, an important mechanism for reusing design artifacts. Libraries are ordinary GME projects; indeed every GME project (including the ones that import libraries themselves) can be imported in a project as a library. The only prerequisite is that both the library and the target project are based on the same version of the same paradigm.

When a library is imported, it is copied into the target project as a whole, so that the root folder of the library becomes an ordinary (non-root folder) in the target. The copy is indicated with a special flag that dictates read-only access to this part of the target project.

The primary way of using libraries is to create subtypes and instances from the library objects. It is also possible to refer to library objects through references. Apart from being read-only, objects imported through the library are equivalent to objects created from scratch.

Library objects can easily be recognized in the tree browser. The library root is indicated with a special icon, and if the browser displays access icons, all library objects are marked to indicate read-only access.

To import a library in a project, use the **Attach library...** command of the **Model Browser** context menu. It is possible to attach libraries to folders only. The folder that receives the library must be a legal container in the root folder according to the paradigm. Since many paradigms do not allow the root folder to be instantiated at other points in the model tree, the root folder of any project is exempt from this rule, i.e. it is possible to attach a library to the root folder even if the paradigm does not allow that.

If the original library project changes, it is not automatically reflected in the projects that import it. It is possible, however, to refresh the imported library images through the **Refresh library...** function in the browser context menu. It is possible to specify an alternate name for the library, in case it has been moved, for example.

6.1. Library Refresh

To support a successful refresh, a GME model has GUIDs: unique ids that are assigned to each FCO and Folder. This enables the correct and unambiguous restoration of relationships upon a **Refresh Library** operation.

Generally speaking, a refresh operation consists of restoring every relation which crosses the host project—library border. These relationships are as follows:

- a reference in the host project pointing to a library element
- a connection in the host project, which is connected to a referenceport that references a library model's port (references to library models with ports have references to the ports, known as referenceports)
- library-derived subtypes in the host project

When a library is refreshed, the binary representation is loaded from the library's `.mga` file and the border-crossing relationships are redirected from the old library to the new one. Note that because libraries are read only, there are no relationships pointing from the library to the host project. This redirection process takes place in the following order:

- base-derived relationships are loosened to enable easier update later (step 0),
- references to old library elements are redirected to the corresponding new library element (step 1),
- connections involving referenceports are reconnected to the corresponding new library referenceport (step 2),

- model subtypes are synchronized (step 3), for example, the basetype in the library might have been enriched to contain new elements which need to be propagated down into the subtypes in the host project (step 3),
- special model children (connections) are synchronized (step 4),
- strict base-derived relationships are restored (step 5).

After every relationship is restored, the old library is unloaded from the host project. Log messages provide feedback in case of a failure. Since libraries are read-only, no nested library can be refreshed in a host project. In such a case, the user needs to go down to the very bottom of the cascading libraries (i.e. open them in GME), and refresh them in their containing project, then do an upward step-by-step refresh.

Note

The refresh feature creates a new version of the library regardless of whether or not the library was altered.

Note

It is recommended to carefully check the models after a refresh operation, especially if non-trivial changes were applied to the library.

6.1.1. Data file compatibility issues

The downside of modifying the internal representation of elements (assigning unique ids) is that backward compatibility was broken in case of XML files. A model created with a new version of GME and exported as a `.xme` file will not be read by older GME releases. The forward compatibility in case of `.xme` files is trivial; unique ids are assigned on the fly when importing files created with old versions of GME. Binary forward compatibility (`.mga` files) is also made possible with an on the fly assignment of unique ids upon the **OpenProject** operation.

6.2. Libraries and Metamodeling

Metamodels can be composed easily using the library feature. If a metamodeler attaches a library to a host metamodel, then the metainterpreter will create a composite paradigm, which corresponds to the union of the two metamodels. The host metamodel (without the library) might define a paradigm, and the library itself might define another paradigm that is why we can call these sub-metamodels which define sub-paradigms. With certain restrictions (e.g. no equivalence operator is used to unite two elements from two sub-metamodels) it can be said that any model valid in one of the sub-paradigms is a valid model in the composite paradigm as well. This means that it is possible to import a sub-paradigm model (in `.xme` format) into an opened composite paradigm model.

Furthermore, a model in the composite paradigm is able to host sub-paradigm models as libraries, by performing an on-the-fly conversion of the sub-paradigm model to the composite paradigm while attaching as a library. Components (e.g. interpreters) written for a sub-paradigm can also be reused for the composite paradigm, provided the user registers the component for the composite paradigm as well: a comma delimited list of paradigm names must be provided in the `ComponentConfig.h` file (`#define PARADIGMS` definition).

Metamodel composition is a nice feature if we obey certain restrictions. One of them is the aforementioned restriction on equivalence operators. The second one is that we can't have conflicting names in the sub-languages, because of the unique name requirement of the composite metamodel. To allow composition in such cases, namespaces were introduced in the MetaGME environment, namely the `MetaInterpreter`

is capable of sorting elements into namespaces based on which part of the metamodel they reside in: objects defined in a library will be defined in the library namespace (if specified), and objects defined in the host metamodel will be assigned the main namespace (if specified). More specifically, the namespace definitions are assigned to rootfolders (since libraries appear in a project as an element of type rootfolder). Every element contained by that rootfolder is defined in that namespace. The namespace assignment can be done through the *NamespaceConfig* interpreter, which writes the specified values in the rootfolder's registry. If an empty string is specified then no namespace is assigned to elements, otherwise, a name of the 'namespace::kindname' form will be assigned. In case of nested libraries namespace modification is not possible; such values will be shown grayed out by the *NamespaceConfig* interpreter.

After setting the needed namespaces, the user might invoke the metainterpreter to create a composed paradigm, which will have no conflicting names. During modeling in this composed paradigm, the kindnames of the objects will contain the namespace information as a prefix of the real kind name, so that objects in the **PartBrowser** will be displayed with their fully qualified name.

Regarding the features which we mentioned in case of composed metamodels, there are some workarounds as follows:

6.2.1. Importing a sub-paradigm model into a composed paradigm model

In case the sub-metamodel is metainterpreted on its own with an assigned namespace (i.e. the same namespace is set as in the case when is used as a library) then every model built with this paradigm is trivially importable/attachable to a composed paradigm model.

In case the sub-metamodel is either not assigned a namespace or used with a different namespace, kindname matching requires some user interaction: the *MgaResolver* component pops up a dialog where the user can specify how kindnames need to be altered to be valid element names in the target (composed paradigm). Users can select from name truncation, prefixing or migrating. The prefixing option will prefix every kindname parsed during the import process with the specific string, thus it is suitable for doing a simple transformation such as: every element without a namespace will be regarded as being in a certain namespace: "MyModel" element transformed to "MyNS::MyModel." The truncation option does the opposite, this being suitable for importing composed paradigm models into sub- paradigm models if the model contains only sub-paradigm elements. Finally, the migration option allows any element from one namespace to be regarded as being in another namespace: every element prefixed with (found in) "MyNS::" namespace will be prefixed with (migrated into) "YourNS::" namespace.

6.2.2. Re-using a component in a composed paradigm

An existing component (interpreter, add-on) can be re-used in a composed paradigm if slight modification is made to the code, which will not affect the component's behavior. A component might set the namespace it is interested in, i.e. the default namespace, with a *IMgaTerritory::SetNamespace* method call. Raw COM component authors are probably familiar with *IMgaTerritories* and their relationship with Transactions and interpreters. BON2 component users need not deal with Territories and Transactions, as it is enough to call the *BON::ProjectImpl::setNmspc()* method.

By setting the default namespace as mentioned above, a component can access kind names in their shorter form (without the namespace prefix) in case an element is from the default namespace. For elements in other namespaces than the default one, the kindname still will be a fully qualified one, with the namespace as a prefix.

Thus, if an interpreter asks for all children with "MyModel" kind (short form) it will get back only those *MyModel* elements which are have "<<defaultNamespace>>::MyModel" kind and will not be confused with elements of "<<anotherNamespace>>::MyModel" kind. If a default namespace

is set and a “<<defaultNamespace>>::MyModel” element is queried for its kind it will return MyModel only; if “<<anotherNamespace>>::MyModel” object is queried for its kind it will return “<<anotherNamespace>>::MyModel”.

Add-ons and decorators require more care than interpreters, because they share a territory, in contrast to the interpreters, which own their territory exclusively. Since the namespace an add-on sets on the Territory might be overwritten by the second add-on, it is required to set the preferred namespace on every entry point into the add-on library. In case of interpreters, it is generally enough to set the namespace at the `InvokeEx()`'s first line. In case of add-ons and decorators, all exposed methods (which can be called through the COM interface) need to do this.

BON2 components based on BonExtender generated code require one additional modification because of the special `IMPLEMENT_BONEXTENSION` macros, which contain global variable definitions holding kindname strings, which can't be affected by the territory's actual namespace setting, because their initialization is made when the `.dll` is loaded. To find the kindnames these macros refer to in a composite paradigm environment, developers must `#define` `NAMESPACE_PREF` in the `ComponentConfig.h` file to the string that will be used to prefix the kind name strings used in the `IMPLEMENT_BONEXTENSION` macros.

6.2.3. Defining constraints in a composed metamodel

If namespaces are defined for the library and the host project, then the constraints in the host project need to be written in fully qualified form. However, the constraints defined in libraries may remain untouched (use terms of the sub-paradigm). The Constraint Manager recognizes that the types are defined there using short names, so it will prefix them automatically.

7. Decorators

GME v1.2 and later implements object drawing in a separate pluggable COM module making domain-specific visual representation a reality.

Replacing the default implementation basically consists of two steps. First we have to create a COM based component, which implements the `IMgaElementDecorator` COM interface. Second, we have to assign this decorator to the classes in our metamodel (or for the objects in our model(s) if we want to override the default decorator specified in the metamodel).

Decorators for GME v7.6.29 and before used the `IMgaDecorator` COM interface for implementation, and used the plain Windows GDI graphical subsystem to draw the graphics. Newer GME versions use `IMgaElementDecorator` interface and GDI+ (Gdiplus) for drawing the objects. New GME versions still support old decorators, but mixing the old GDI and the new GDI+ technology can confuse the system (resulting in graphical errors), so it is highly advisable to update old decorators to the new scheme. Also, it is advisable to use Release version decorators with Release version GME, and Debug version decorators with Debug version GME.

GME instantiates a separate decorator for each object in each aspect, so we have to keep our decorator code as compact as possible. Decorator components always have to be in-process servers. Using `DecoratorLib`, C++, GDI+, ATL and/or MFC is the recommended way to develop decorators.

7.1. The `IMgaElementDecorator` interface

The following diagram shows the method invocation sequence on the `IMgaElementDecorator` interface. Understanding the protocol between GME and the decorators is the key to developing decorators. All the methods on the decorator interface are called by GME (there is `IMgaElementDecoratorEvents` interface for well defined callback cases). The direction column in the diagram shows the direction of the information flow.

GME always calls your methods in a read-only MGA transaction. You must not initiate new transactions in your decorator. `SaveState()` is the only exception to this rule. This method is called in a read-write transaction, therefore, this is the only place where you can store decorator specific information in the MGA project.

Table 2. Simplified lifecycle of a decorator object

GME	Dir	Decorator
	=>	decorator class constructor
	=>	<code>GetFeatures([out] features)</code>
	=>	<code>SetParam([in] name, [in]value)</code>
	<=	<code>GetParam([in] name, [out] value)</code>
	=>	<code>InitializeEx([in] mgaproject, [in] mgametapart, [in] mgafco, [in] eventSink, [in] parentWnd)</code>
	<=	<code>GetPreferredSize([out] sizex, [out] sizey)</code>
	<=	<code>GetPorts([out] portFCOs)</code>
	=>	<code>SetLocation([in] sx, [in] sy, [in] ex, [in] ey)</code>
	<=	<code>GetPortLocation([in] fco, [out] sx, [out] sy, [out] ex, [out] ey)</code>
	<=	<code>GetLabelLocation([out] sx, [out] sy, [out] ex, [out] ey)</code>

GME	Dir	Decorator
	<=	GetLocation([out] sx, [out] sy, [out] ex, [out] ey)
	=>	SetActive([in] isActive)
	=>	DrawEx([in] hDC, [in] gdip)
	=>	SaveState()
	=>	Destroy()

7.1.1. IMgaElementDecorator Functions

```
HRESULT GetFeatures([out] feature_code *features)
```

This method tells GME which features the decorator supports. Available feature codes are (can be combined using the bitwise-OR operator):

- `F_RESIZABLE` : decorator supports resizable objects
- `F_MOUSEEVENTS` : decorator handles mouse events
- `F_HASLABEL` : decorator draws labels for objects (outside of the object)
- `F_HASSTATE` : decorator wants to save information in the MGA project
- `F_HASPORTS` : decorator supports ports in objects
- `F_ANIMATION` : decorator expects periodic calls of its draw method

```
HRESULT SetParam([in] BSTR name, [in] VARIANT value)
```

If there are some parameters specified for this decorator in the meta model, GME will call this method for each parameter/value pair.

```
HRESULT GetParam([in] BSTR name, [out] VARIANT *value)
```

The decorator needs to be able to give back all the parameter/value pairs it got with the `SetParam(...)` method.

```
HRESULT InitializeEx([in] IMgaProject* project, [in] IMgaMetaPart *meta, [in] IMgaFCO
*obj, [in] IMgaCommonDecoratorEvents* eventSink, [in] ULONGLONG parentWnd)
```

This is your constructor-like function. Read all the relevant data from the project and cache them for later use (it is a better approach than querying the MGA project in your drawing method all the time). GME will instantiate a new decorator if its MGA object changes.

The decorator can signal certain operations to GME with the `eventSink` interface. For example decorator should notify GME that a title editing operation is started, and also when the operation is finished.

`parentWnd` can be used when the decorator wants to create some dialog window. In that case the parent window of the created dialog should be this parent window. Currently this is used when creating the in-place title editing window. If we would use just the desktop window as a parent, the application would flicker during the creation and destruction of the dialog.

You can use the `DecoratorUtils` helper facility during the initialization of the decorator and also at later time. The facility provides easier access to preference and attribute values of an object. Besides that, it contains font, pen, brush and bitmap caches. There's a `PreferenceMap` class used during initialization to pass various settings, preference and attribute values easily among the Decorator Part objects of the Decorator Part hierarchy.

```
HRESULT GetPreferredSize([out] long* sizex, [out] long* sizey)
```

Your decorator can give GME a hint about the size of the object to be drawn. You can compute this information based on the inner structure of the object or based on a bitmap size, or even you can read these values from the registry of the object. However, GME may not take this information into account when it calls your `SetLocation()` method. All the size and location parameters are in logical units.

Note that GME really tries to preserve the size what you specified, but because of grid snapping logics and other reasons the final size of the decorator can differ with couple of pixels.

```
HRESULT GetPorts([out, retval] IMgaFCOs **portFCOs)
```

If your decorator supports ports, it should give back a collection of MGA objects that are drawn as ports inside the decorator. GME uses this method along with successive calls on `GetPortLocation()` to figure out where can it find port objects.

```
HRESULT SetLocation([in] long sx, [in] long sy, [in] long ex, [in] long ey)
```

You have to draw your object exactly to this position in this size. There is no exemption to this. GME always calls this method before `DrawEx()`.

```
HRESULT GetPortLocation([in] IMgaFCO *fco, [out] long *sx, [out] long *sy, [out] long *ex, [out] long *ey)
```

See description of `GetPorts()`. Position coordinates are relative to the parent object.

```
HRESULT GetLabelLocation([out] long *sx, [out] long *sy, [out] long *ex, [out] long *ey)
```

If you support label drawing, you have to specify the location of the textbox of your label. This can reside outside of the object. GME will call `SetLocation()` before this method.

```
HRESULT GetLocation([out] long *sx, [out] long *sy, [out] long *ex, [out] long *ey)
```

Return the coordinates you got in `SetLocation()`.

```
HRESULT SetActive([in] VARIANT_BOOL isActive)
```

GME calls this method with `VARIANT_FALSE` if your object must be shown in gray color. (Eg.: GME was switched into “set” mode.) By default the decorator should paint its object with the active color.

```
HRESULT DrawEx([in] HDC hdc, [in] ULONGLONG gdi)
```

You should draw the graphical representation of the decorator using the supplied `Gdiplus::Graphics*` object. You have all the required information when this method is called. Because a `Windows Gdiplus::Graphics*` is supplied, the decorator has to be an in-process server. `HDC` is provided only for backward compatibility, it is highly recommended to use the `Gdiplus::Graphics` interface. `DecoratorUtils` facility makes drawing of bitmaps, shapes and text very easy.

```
HRESULT SaveState()
```

Because this is the only method your decorator is in read-write transaction mode, it has to backup all the permanent data here.

```
HRESULT Destroy()
```

A destructor-like function. Releasing all your COM pointers (only if it is needed, so if the pointer is not an intelligent auto pointer like `CComPtr<Ixyz>`) and allocated resources is a good practice here.

```
HRESULT SetSelected([in] VARIANT_BOOL isSelected)
```

GME calls this method when the selected state of the object is changed. You might want to display slightly different appearance if it is selected or not. Currently the default decorator uses this to allow some operations, for example you can only start to resize a decorator when it is selected. The decorator is the one who decides if a resize operation should be started so it is needed to know if the object is selected. (Note: GME draws the selection trackers.)

```
HRESULT MouseMoved([in] ULONG nFlags, [in] LONG pointx, [in] LONG pointy, [in] HDC transformHDC)
```

GME forwards this message to the decorator when Window's WM_MOUSEMOVE is received (more precisely: MFC's OnMouseMove is received) over the view window and the cursor is close to or above the particular decorator's area. The decorator can decide if it wants to start some operation or change the cursor (return S_DECORATOR_EVENT_HANDLED) or do not do anything special (return S_DECORATOR_EVENT_NOT_HANDLED).

nFlags: Indicates whether various virtual keys are down. This parameter can be any combination of the following values:

- MK_CONTROL : Set if the CTRL key is down.
- MK_LBUTTON : Set if the left mouse button is down.
- MK_RBUTTON : Set if the right mouse button is down.
- MK_SHIFT : Set if the SHIFT key is down.

pointx and pointy: specifies the x- and y-coordinate of the cursor. These coordinates are always relative to the upper-left corner of the *model*. Because the model window can be magnified and it can be scrolled the cursor position to the model *window* (HWND) can be different. If somebody wants to calculate the relative position to the upper-left corner of the window, the transformHDC HDC is supplied for that purpose. Using this HDC the coordinates can be transformed.

If there are more decorators below or close to the cursor, GME forwards the message until the event is not handled by one of them. If none of the decorators treat the message, then GME's event handler code will take effect.

```
HRESULT MouseLeftButtonDown([in] ULONG nFlags, [in] LONG pointx, [in] LONG pointy, [in] HDC transformHDC)
```

GME forwards this message to the decorator when Window's WM_LBUTTONDOWN is over the view window and the cursor is close to or above the particular decorator's area. The decorator can decide if it wants to start some operation or change the cursor (return S_DECORATOR_EVENT_HANDLED) or not do anything special (return S_DECORATOR_EVENT_NOT_HANDLED).

For the explanation of parameters and return values see the MouseMoved interface function's explanation.

The same things apply for the following interface functions: MouseLeftButtonUp, MouseLeftButtonDoubleClick, MouseRightButtonUp, MouseRightButtonDoubleClick, MouseMiddleButtonDown, MouseMiddleButtonUp, MouseMiddleButtonDoubleClick.

```
HRESULT MouseRightButtonDown([in] ULONGLONG hCtxMenu, [in] ULONG nFlags, [in] LONG pointx, [in] LONG pointy, [in] HDC transformHDC)
```

This message works almost the same way as the previous mouse messages except one thing: right mouse button click is the regular method to bring up context menus. When WM_RBUTTONDOWN is received by GME, it constructs a specific context menu. If there are decorators below or near the cursor, they get the opportunity to add some additional menu items into the menu. If any of the decorators add menu items (or

complete submenu) to the supplied context menu handle, GME creates a submenu titled “Decorator Edit”, and puts the decorator's context menu as a submenu in that.

You should also treat `MenuItemSelected` function and call appropriate function on the `IMgaCommonDecoratorEvents` interface.

```
HRESULT OperationCanceled()
```

The decorator receives this message from GME if some operation which was initiated by the decorator (through the `IMgaCommonDecoratorEvents` interface, like label editing, window resizing or any other operation) was canceled because of some reason. The decorator should free any resources associated with the initiated operation on the decorator's side.

```
HRESULT DragEnter([out] ULONG* dropEffect, [in] ULONGLONG pColeDataObject, [in] ULONG  
keyState, [in] LONG pointx, [in] LONG pointy, [in] HDC transformHDC)
```

The decorator receives this if the system wants to determine whether a drop can be accepted, and, if so, the effect of the drop. This message corresponds to the `DragEnter` message of the `IDropTarget` COM interface, see MSDN. Other functions of this native Windows interface is `DragLeave`, `DragOver` and `Drop`, these messages work with each other. For a simple example you may take a look at the `NewSample` decorator code in the `SDK\Decorator Examples` directory.

`dropEffect`: On entry, a pointer to the value of the `pdwEffect` parameter of the `DoDragDrop` function. On return, must contain one of the effect flags from the `DROPEFFECT` enumeration, which indicates what the result of the drop operation would be.

`pColeDataObject`: Pointer to the `ColeDataObject` data object. This data object contains the data being transferred in the drag-and-drop operation. If the drop occurs, this data object will be incorporated into the target.

`keyState`: The current state of the keyboard modifier keys on the keyboard. Possible values can be a combination of any of the flags `MK_CONTROL`, `MK_SHIFT`, `MK_ALT`, `MK_BUTTON`, `MK_LBUTTON`, `MK_MBUTTON`, and `MK_RBUTTON`.

`pointx` and `pointy`: specifies the x- and y-coordinate of the cursor. These coordinates are always relative to the upper-left corner of the *model*. Because the model window can be magnified and it can be scrolled the cursor position to the model *window* (`HWND`) can be different. If somebody wants to calculate the relative position to the upper-left corner of the window, the `transformHDC` `HDC` is supplied for that purpose. Using this `HDC` the coordinates can be transformed.

If there are more decorators below or close to the cursor, GME forwards the message until the event is not handled by one of them. If none of the decorators treat the message, then GME's event handler code will take effect.

```
HRESULT DragOver([out] ULONG* dropEffect, [in] ULONGLONG pColeDataObject, [in] ULONG  
keyState, [in] LONG pointx, [in] LONG pointy, [in] HDC transformHDC)
```

GME sends calls that function on the decorator in order to be able to provide target feedback to the user and communicates the drop's effect to the `DoDragDrop` function so it can communicate the effect of the drop back to the source.

For the explanation of the parameters see `DragEnter` function.

```
HRESULT Drop([in] ULONGLONG pColeDataObject, [in] ULONG dropEffect, [in] LONG pointx,  
[in] LONG pointy, [in] HDC transformHDC)
```

GME sends calls that function to instruct the decorator to incorporate the source data into the target place, remove the target feedback, and release the data object.

For the explanation of the parameters see `DragEnter` function.

```
HRESULT DropFile([in] ULONGLONG hDropInfo, [in] LONG pointx, [in] LONG pointy, [in]
HDC transformHDC)
```

`DropFile` is a completely different way to handle possible drop operations, than the previously seen three `IDropTarget`-like methods. While the previous three method usually used during drag-drop operations initiated inside the GME environment, `DropFile` only capable of dealing with file drop operations.

`hDropInfo`: Handle to a native Win32 internal drop structure. Use the `DragQueryFile` Win32 API function to query and treat this handle.

For a simple example you may take a look at the `NewSample` decorator code in the `SDK\Decorator Examples` directory.

For the explanation of the coordinate and coordinate transformation parameters, see `DragEnter` function.

7.2. The `IMgaElementDecoratorEvents` interface

On the `IMgaElementDecorator` interface GME can communicate towards the decorators. Since the new decorators supposed to be able to initiate label editing, resize and other operations, an interface is needed through which the decorator can communicate back to GME. This is the `IMgaElementDecoratorEvents` interface.

One of the main reasons for that is because of a thing mentioned earlier: GME always calls `IMgaElementDecorator` methods in a read-only MGA transaction. Because GME refreshes the view after every operation, a decorator cannot open a transaction because the refresh includes the destruction of the decorator itself and a creation of a new decorator. For that reason GME should open and commit the transaction associated to the needed operation somehow. This is done with the help of `IMgaElementDecoratorEvents` interface.

Usually events which signal some kind of operation start can open a transaction on the GME's side. Often for performance reasons the transaction is only opened in the operation finished function and the transaction is committed during the final call (`LabelEditingFinished`, `WindowResizeFinished`).

The interface also contains other useful functions to indicate cursor change on the decorator side, cancellation of an operation, or needed UI refresh.

The following table illustrates a label editing process:

Table 3. Label editing process

GME	Dir	Decorator
	=>	<code>MouseMoved(nFlags, pointx, pointy, transformHDC)</code>
	=>	<code>SetSelected(VARIANT_TRUE)</code>
	<=	<code>CursorChanged(LONG newCursorID)</code>
	=>	<code>MouseLeftButtonDown(nFlags, pointx, pointy, transformHDC)</code>
	<=	<code>LabelEditingStarted(nFlags, left, top, right, bottom)</code>
	<=	<code>LabelChanged(BSTR newLabel)</code>
	<=	<code>LabelEditingFinished(nFlags, left, top, right, bottom)</code>
	<=	<code>CursorRestored()</code>

The following table illustrates a window resize process:

Table 4. Window resize process

GME	Dir	Decorator
	=>	MouseMoved(nFlags, pointx, pointy, transformHDC)
	=>	SetSelected(VARIANT_TRUE)
	<=	CursorChanged(LONG newCursorID)
	=>	MouseLeftButtonDown(nFlags, pointx, pointy, transformHDC)
	<=	WindowResizingStarted(nFlags, left, top, right, bottom)
	=>	MouseMoved(nFlags, pointx, pointy, transformHDC)
	<=	WindowResizing(nFlags, left, top, right, bottom)
	=>	MouseLeftButtonUp(nFlags, pointx, pointy, transformHDC)
	<=	WindowResized(nFlags, deltax, deltay)
	<=	WindowResizingFinished(nFlags, left, top, right, bottom)
	<=	CursorRestored()

7.2.1. IMgaElementDecoratorEvents Functions

```
HRESULT Refresh([in] refresh_mode_enum refreshMode)
```

This function signals to GME that a UI refresh is needed. The decorator can specify to GME what kind of refresh is wanted:

- `RM_NOREFRESH` : No refresh
- `RM_REDRAW_SELF` : A graphical UI redraw
- `RM_REGENERATE_SELF` : complete refresh of the owner model's view including regeneration of the decorators
- `RM_REGENERATE_PARENT_ALSO` : complete refresh of the owner model's parent model's view (if it is open) including regeneration of the decorators
- `RM_REGENERATE_ALL_VIEWS` : regeneration of all open views

```
HRESULT OperationCanceled()
```

The decorator signals GME that an initiated operation was canceled because of some reason. The reason can be anything but it emerged on the decorator's side, and a cancel decision was made. The operation was started by the decorator also in the past.

```
HRESULT CursorChanged([in] LONG newCursorID)
```

The decorator signals GME that the cursor is changed. The `newCursorID` parameter indicates the new form of the cursor.

```
HRESULT CursorRestored()
```

The decorator signals GME that the previously changed cursor is restored to its original state.

```
HRESULT LabelEditingStarted([in] LONG left, [in] LONG top, [in] LONG right, [in] LONG bottom)
```

The decorator tells GME that a label editing operation is started. The coordinates specify the operation's (the label) area.

```
HRESULT LabelEditingFinished([in] LONG left, [in] LONG top, [in] LONG right, [in] LONG bottom)
```

The decorator tells GME that a label editing operation is finished. The coordinates specify the operation's (the label) area. This should be the last message, because this will issue the transaction commit command. The LabelChanged message must precede it!

```
HRESULT LabelChanged([in] BSTR newLabel)
```

The decorator tells GME that the new value of the label is finalized and the transaction can be opened. The newLabel is passed to GME, but the decorator is responsible for issuing the actual label change command, because it can be very different: changing a preference or an attribute. The decorator must call LabelChanged function before modifying the mga object. The decorator also must call the LabelEditingFinished function after that, in order to have the transaction committed by GME.

```
HRESULT LabelMovingStarted([in] LONG nFlags, [in] LONG left, [in] LONG top, [in] LONG right, [in] LONG bottom)
```

The decorator tells GME that a label moving operation is started. The coordinates specify the operation's (the label) area. Note that currently none of the GME's bundled decorators (default (box) decorator, UML decorator, meta decorator) use this feature.

nFlag came from a GME message (see MouseLeftButtonDown above for example), and can be forwarded back to GME for completeness, but currently GME doesn't use it.

```
HRESULT LabelMoving([in] LONG nFlags, [in] LONG left, [in] LONG top, [in] LONG right, [in] LONG bottom)
```

The decorator tells GME that the label position is changed, and we are still in the label moving operation. The coordinates specify the actual location of the label.

```
HRESULT LabelMovingFinished([in] LONG nFlags, [in] LONG left, [in] LONG top, [in] LONG right, [in] LONG bottom)
```

The decorator tells GME that a label moving operation is finished. The coordinates specify the actual location of the label. This should be the last message, because this will issue the transaction commit command. The LabelMoved message must precede it!

```
HRESULT LabelMoved([in] LONG nFlags, [in] LONG x, [in] LONG y)
```

The decorator tells GME that the new location of the label is finalized and the transaction can be opened. The x and y parameters are the delta values compared to the previous location of the label. The decorator must call LabelMoved function before modifying the mga object. The decorator also must call the LabelMovingFinished function after that, in order to have the transaction committed by GME.

```
HRESULT LabelResizingStarted([in] LONG nFlags, [in] LONG left, [in] LONG top, [in] LONG right, [in] LONG bottom)
```

The decorator tells GME that a label resizing operation is started. The coordinates specify the operation's (the label) area. Note that currently none of the GME's bundled decorators (default (box) decorator, UML decorator, meta decorator) use this feature.

nFlag came from a GME message (see MouseLeftButtonDown above for example), and can be forwarded back to GME for completeness, but currently GME doesn't use it.

```
HRESULT LabelResizing([in] LONG nFlags, [in] LONG left, [in] LONG top, [in] LONG right, [in] LONG bottom)
```

The decorator tells GME that the label size is changed, and we are still in the label resizing operation. The coordinates specify the actual location of the label.

```
HRESULT LabelResizingFinished([in] LONG nFlags, [in] LONG left, [in] LONG top, [in] LONG right, [in] LONG bottom)
```

The decorator tells GME that a label resizing operation is finished. The coordinates specify the actual location of the label. This should be the last message, because this will issue the transaction commit command. The `LabelResized` message must precede it!

```
HRESULT LabelResized([in] LONG nFlags, [in] LONG x, [in] LONG y)
```

The decorator tells GME that the new location of the label is finalized and the transaction can be opened. The `x` and `y` parameters are the delta values compared to the previous location of the label. The decorator must call `LabelResized` function before modifying the `mga` object. The decorator also must call the `LabelResizingFinished` function after that, in order to have the transaction committed by GME.

```
HRESULT GeneralOperationStarted([in] ULONGLONG operationData)
```

The decorator tells GME that some editing operation is started. GME will open a transaction as a result of this message. If the decorator handles some user defined data to the GME in the parameter, it will get it back later when the `GeneralOperationFinished` is called. Decorator can give a pointer to a memory object or just `NULL` as a data.

```
HRESULT GeneralOperationFinished([out] ULONGLONG* operationData)
```

The decorator tells GME that the previously started operation is finished. GME will commit the opened transaction as a result of this message. If the decorator wants to cancel the operation, it can call the `OperationCanceled` function.

```
HRESULT WindowMovingStarted([in] LONG nFlags, [in] LONG left, [in] LONG top, [in] LONG right, [in] LONG bottom)
```

The decorator tells GME that a window moving operation is started. The coordinates specify the operation's (the window) area. Note that currently none of the GME's bundled decorators (default (box) decorator, UML decorator, meta decorator) use this feature.

`nFlag` came from a GME message (see `MouseLeftButtonDown` above for example), and can be forwarded back to GME for completeness, but currently GME doesn't use it.

```
HRESULT WindowMoving([in] LONG nFlags, [in] LONG left, [in] LONG top, [in] LONG right, [in] LONG bottom)
```

The decorator tells GME that the window position is changed, and we are still in the window moving operation. The coordinates specify the actual location of the window.

```
HRESULT WindowMovingFinished([in] LONG nFlags, [in] LONG left, [in] LONG top, [in] LONG right, [in] LONG bottom)
```

The decorator tells GME that a window moving operation is finished. The coordinates specify the actual location of the window. This should be the last message, because this will issue the transaction commit command. The `WindowMoved` message must precede it!

```
HRESULT WindowMoved([in] LONG nFlags, [in] LONG x, [in] LONG y)
```

The decorator tells GME that the new location of the window is finalized and the transaction can be opened. The `x` and `y` parameters are the delta values compared to the previous location of the window. The decorator must call `WindowMoved` function before modifying the `mga` object. The decorator also must call the `WindowMovingFinished` function after that, in order to have the transaction committed by GME.

```
HRESULT WindowResizingStarted([in] LONG nFlags, [in] LONG left, [in] LONG top, [in]
LONG right, [in] LONG bottom)
```

The decorator tells GME that a window resizing operation is started. The coordinates specify the operation's (the window) area. Note that currently none of the GME's bundled decorators (default (box) decorator, UML decorator, meta decorator) use this feature.

nFlag came from a GME message (see `MouseDownButtonDown` above for example), and can be forwarded back to GME for completeness, but currently GME doesn't use it.

```
HRESULT WindowResizing([in] LONG nFlags, [in] LONG left, [in] LONG top, [in] LONG
right, [in] LONG bottom)
```

The decorator tells GME that the window size is changed, and we are still in the window resizing operation. The coordinates specify the actual location of the window.

```
HRESULT WindowResizingFinished([in] LONG nFlags, [in] LONG left, [in] LONG top, [in]
LONG right, [in] LONG bottom)
```

The decorator tells GME that a window resizing operation is finished. The coordinates specify the actual location of the window. This should be the last message, because this will issue the transaction commit command. The `WindowResized` message must precede it!

```
HRESULT WindowResized([in] LONG nFlags, [in] LONG x, [in] LONG y)
```

The decorator tells GME that the new location of the window is finalized and the transaction can be opened. The `x` and `y` parameters are the delta values compared to the previous location of the window. The decorator must call `WindowResized` function before modifying the mga object. The decorator also must call the `WindowResizingFinished` function after that, in order to have the transaction committed by GME.

7.3. Visual Studio 2008 Decorator Wizard

The first time you wish to create a decorator project, you must run `C:\Program Files\GME\SDK\DecoratorWizard\setup90.js`. This registers the decorator project type in Visual Studio.

To create a Decorator project, open Visual Studio 2008. Go to **File | New Project**. Under **Visual C++**, select **GME**, then the Decorator template. Give the project a name, then hit **OK**. The wizard generates UUIDs/CLSIDs/GUIDs automatically, and does every required modification to the skeleton code.

Figure 27. Starting the Decorator Wizard

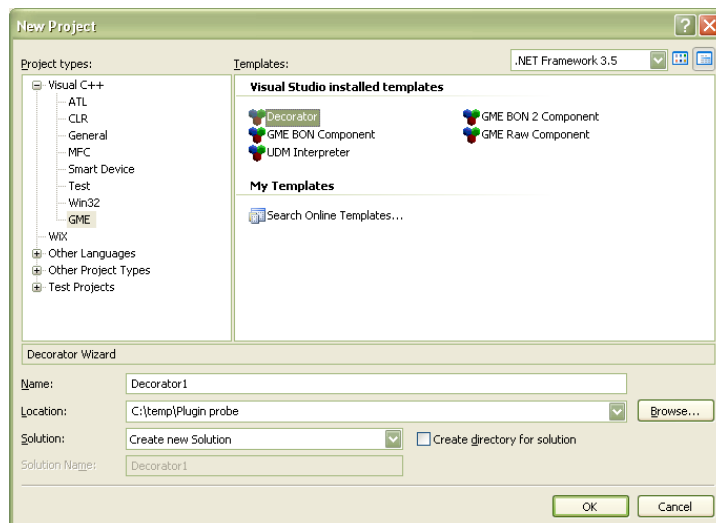

The resulting configuration is a ready-to-compile Visual Studio 2008 Solution leveraging capabilities of the new `DecoratorLib` library and shows the same demo features as the `NewSample` sample decorator code. The user is expected to implement the component by modifying appropriate files of the skeleton code. For further details see the section on `DecoratorLib` and decorator example codes.

After building the project, the decorator `.dll` is registered.

7.4. Using the Decorator sample/skeleton codes

The recommended method for decorator development is the Decorator Wizard, see previous section. If for some reason you want to edit sample codes directly, there are still two types of sample projects provided in the `C:\Program Files\GME\SDK\Decorator Examples` directory.

The `NewSample` sample takes advantage of the class hierarchy and utilities provided by the new `DecoratorLib` library. The source code is intended to be used with Microsoft Visual Studio 2008. Because of the new `DecoratorLib`, the sample can inherit resizability properties and in-place label editing features from the infrastructure. It also demonstrates context menu usage and drag-drop handling.

In case of the `NewSample` decorator you first have to adjust `DecoratorLib.vcproj` project file path (this is part of the solution) in the Visual Studio Solution file. Unfortunately in case of Solution (`.sln`) files Visual Studio cannot resolve environment variables so `GME_ROOT` cannot be used. Your solution's relative path is probably different from the SDK sample so you have to tune it. This is not a problem with the Wizard because it does this all automatically.

The `PlainSample` source code provides a really stripped down example implementation containing only the flat implementation of the interface and not leveraging the new `DecoratorLib`. The example still demonstrates very simple drawing, context menu extension and file drop handling. This sample code intended to be used with Microsoft Visual Studio .NET 2003.

Modifying the `DecoratorConfig.h` file would be your first step when using the skeleton code.

The following modifications have to be made:

- Give a new value to `TYPELIB_UUID` (a new ID can be generated by the **guidgen** tool, found in Visual Studio)
- Give a new value to `TYPELIB_NAME` (at least replace the string between the parenthesis)
- Give a new value to `COCLASS_UUID` (a new ID can be generated by the **guidgen** tool, found in Visual Studio)
- Give a new value to `COCLASS_NAME` (at least replace the string between the parenthesis)
- Give a new value to `COCLASS_PROGID` (at least replace the last tag of the string)
- Give a new value to `DECORATOR_NAME`
- Set `GME_INTERFACES_BASE` to point to the interfaces directory of your GME source code (or GME installation, if you don't have source code)

You have to make these modifications only once. When you are upgrading your decorator SDK, create a backup of your `DecoratorConfig.h`, and restore it after the upgrade.

7.5. Using the DecoratorLib library

The new box decorator (GME's default decorator), annotator decorator, meta decorator and UML decorator all use the `DecoratorLib` helper library. The goals of this library are as follows:

- It abstracts the COM interface and provides a higher level C++ interface
- It makes COM object handling easier
- It provides several building block classes called “decorator parts”
- With the help of the decorator parts you can get many handy features for free: resizable, in-place text editing, vector shapes, shape shadows and gradient fills
- With the use of the `DecoratorUtil` (it is part of the `DecoratorLib`) it is easier to access preferences and attributes of the mga objects
- `DecoratorUtil` also provides cached pen, brush and font object to make the drawing operations resource aware
- `DecoratorUtil` also make text drawing and measurement and other graphical operations easier.

Using the `DecoratorLib` library requires from you the following in you Visual Studio project:

- Visual Studio 2008 is the supported IDE
- Add `DecoratorLib.vcproj` project (located in the SDK) into your Solution, and set it as a dependency prerequisite for your Decorator project
- Also link `gdiplus.lib` into your project

It is recommended to use the Decorator Wizard to start the development. If you start from scratch for some reason, you can start your project based on the `NewSample` sample decorator, or one of the existing decorators, which are part of the GME source code: `MgaDecorators`, `UML` decorator (source can be found in the SDK also) or `Meta` decorator.

The new class library hierarchy is based on the `PartInterface` C++ interface which is higher-level and much nicer than the plain COM interface level. There's a complete class hierarchy, where the root class is the `PartBase`. You can use `CompositePart` and other `Parts` as building blocks to relatively easily add rich functionality to your decorator. Some typical building blocks:

- `TypeableBitmapPart`: a building block which can display bitmaps. It can also display “type”, “subtype” and “reference” tiny marker icons to clearly indicate these circumstances visually.
- `TypeableLabelPart`: Besides displaying the label of an object and allowing in-place editing of the text, it is able to display type information about the object.
- `ObjectAndTextPart`: `CompositePart` is a general way to put any kind of parts together, but usually a decorator consists of some graphics (bitmap, vectorial) and a label. `ObjectAndTextPart` makes this dual configuration easier to implement.
- `VectorPart`: The vector part uses its own scheme to describe vectorial graphics, but there are several ready-to-use vectorial shapes, like: `TriangleVectorPart`, `EllipseVectorPart` or `DiamondVectorPart`.

The main task is to decide which decorator parts represent the functionality needed by the decorator and instantiate them at the proper time. In the `NewSample` example this place is the `SampleCompositePart::InitializeEx` function, where currently we add a vector part and a label part to the encapsulating composite part. The `UML` and the `Meta` decorator source contains a switch here, the branching decision is made according to the name of the meta object. For example in case of constraint meta elements, the needed constraint vectorial parts are used as the graphical part of the decorator.

You can use the `PreferenceMap` container to pass various settings of the decorators between the parts during the initialization phase.

After building up your decorator you probably want to customize it with extra functionality. You should use the `DecoratorUtils` helper singleton class wherever it's possible to save system resources and you can implement certain tasks easier with it:

- You can more easily access preferences and attributes of the mga objects; see `getAttribute` and `getPreference` functions.
- You can get cached pen, brush and font objects to make the drawing operations resource aware, see `GetFont`, `GetPen`, `GetBrush` functions.
- You can make text drawing and measurement and other graphical operations easier, see: `MeasureText`, `DrawString`, `DrawRect`, `DrawBox`, `getGraphics`, `getBitmap` functions.

7.6. Assigning decorators to objects

You can assign decorators to objects in your meta model or even later in your model(s). In the MetaGME environment there is a `Decorator` attribute for each non-connection FCO where you can specify a COM ProgID along with optional parameter/value pairs for a class. The format of this string is as follows:

```
ProgID param1=value1, param2=value2, ...  
e.g.:  
MGA.Decorator.MetaDecorator showattributes=false, showabstract=true
```

In your models all the non-connection FCOs have a preference setting called `Decorator`. The format of this string is identical to the one in the meta model.

8. Metamodeling Environment

The metamodeling environment has been extended with a new decorator component in version 1.2 or later. It displays UML classes including their stereotypes and attributes. Proxies also show this information. It resizes UML classes accordingly.

GME has a OCL syntax checker add-on for the metamodeling environment. Every time a constraint expression attribute is changed, this add-on is activated. Note that the target paradigm information is not available to this tool, therefore, it cannot check arguments and parameters, such as kindname. These can only be checked at constraint evaluation time in your target environment.

8.1. Step by step guide to basic metamodeling

The following sections describe the concepts that are used to model the output Paradigm.

8.1.1. Paradigm

The Paradigm is represented as the model that contains the UML class diagram. The name of the Paradigm model is the name of the paradigm produced by the interpreter. The attributes of the Paradigm are *Author Information* and *Version Information*.

8.1.2. Folder

A Folder is represented as a UML class of stereotype «folder». Folders may own other Folders, FCOs, and Constraints. Once a Folder contains another container, it by default contains all FCOs, Folders, and Constraints that are in that container. Folders are visualized only in the model browser window of GME, and therefore do not use aspects. A Folder has the *Displayed Name*, and *In Root Folder* attributes.

8.1.2.1. How to specify containment for a Folder

Folder containment applies to Folders and Models that may be contained in a Folder.

In the figure below, the UML diagram outlines the containment scheme of a paradigm for a sports season. To specify containment for a Folder, follow these steps.

1. Create the *Folder* and *item* it contains (through insertion, or dragging from the parts menu)
2. Connect the item to the Folder

Now, the Folder contains the item.

Figure 28. Example of a Folder containment

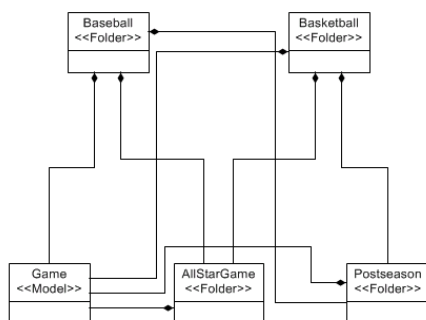

8.1.2.2. FCO

This is a class that is mandatorily abstract. The purpose of this class is to enable objects that are inherently different (Atom, Reference, Set, etc.) to be able to inherit from a common base class.

To avoid confusion with the generalization of modeling concepts (Model, Atom, Set, Connection, Reference) called collectively an “FCO”, and this *kind* of object in the metamodeling environment which is called an “FCO”, the metamodeling concept (that would actually be dragged into a Paradigm model) will be shown in regular font, while the generalization of types will be in italics as *FCO*. An FCO has the *Is Abstract* and *General Preferences* attributes. All *FCO*-s will also have these attributes.

8.1.2.2.1. How to create an FCO

An FCO (like all *FCO*-s) is created by dragging in the atom corresponding to its stereotype, or inserting the atom through the menu.

8.1.2.2.2. How to specify an Attribute for an FCO

1. Create and configure the *Attribute* and the FCO.
2. Connect the *Attribute* to the FCO

Now, the *Attribute* belongs to the FCO.

8.1.2.3. Atom

The Atom is the simplest kind of object in one sense, because it cannot contain any other parts; but it is complex to define because of the many different contributions it can make to a Model, Reference, etc.

An Atom has the *Icon Name*, *Port Icon Name*, and *Name Position* attributes.

8.1.2.3.1. How to set that an Atom is a Port

1. Configure the *Atom* to be a member of a *Model*
2. Click on the attributes of the Containment association between the *Atom* and the *Model*
3. Assert the *Object Is A Port* attribute.

8.1.2.4. Reference

To represent a Reference class, two things must be specified: the FCO to which this Reference refers, and the Model to which the Reference belongs. A Reference has the *Icon Name* and *Name Position* attributes.

Figure 29. Example of a Reference.

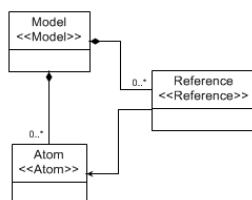

8.1.2.4.1. How to specify containment of a Reference in a Model

1. Connect the *Reference* to the *Model*

2. Resolve the prompt for connection type as “*Containment*”.

8.1.2.4.2. How to specify the FCO to which a Reference refers

1. Connect the Reference to the FCO.
2. If the FCO is of type Model, an additional prompt is displayed (exactly the same as when giving ownership to the Model as in the previous step). This time, choose the “Refer” type of connection. If the FCO is not of type Model, then no additional input is necessary.
3. When specifying the roles to which a Reference may refer (that is, if the referred FCO may play more than one kind of role in a particular Model), the current solution is that it may refer to all roles of that particular kind. However, in the future, this list may be modified during paradigm construction through the help of an add-on.

8.1.3. Connection

Connection In order for a Connection to be legal within a Model, it must be contained through aggregation in that Model. The Connection is another highly configurable concept. The attributes of a Connection include *Name Position*, *1st destination label*, *2nd destination label*, *1st source label*, *2nd source label*, *Color*, *Line type*, *Line end*, and *Line Start*.

Figure 30. Example of a Connection

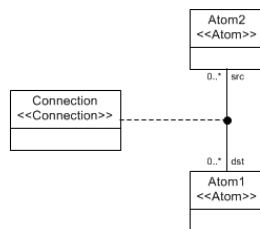

8.1.3.1. How to specify a connection between two Atoms

In addition to Atoms, a Reference to an Atom may also be used as an endpoint of the Connection. Note that Connection is also usable as an endpoint, but there is currently no visualization for this concept.

1. Drag in a *Connector* Atom (the name of the Connector was deleted in the example figure)
2. Connect the source *Atom* to the *Connector*
3. Connect the *Connector* to the destination *Atom*
4. Connect the *Connector* to the *Connection*. Resolve the *Connection* type to “*AssociationClass*”

The rolenames of the connections (“src” and “dst”) denote which of the Atoms may participate as the source or destination of the connection. There may be only one source and one destination connection to the Connector Atom.

Inheritance is a useful method to increase the number of sources and destinations, since all child classes will also be sources and destinations.

Currently, all possible FCO source/destination combinations will be used in the production of the metamodel. However, in future revisions of the metamodeling environment, the list of allowable

connections may be modified at model building time (to eliminate certain possibilities from ever occurring).

8.1.4. Set

The Set is a more general case of the Reference. Sets have the *Icon name*, and *Name Position* attributes.

The members of the Set are “owned” by the Set through the “SetMembership” connection kind (when connecting the Reference to the Set, the user will be prompted to choose between the “SetMembership” and “ReferTo” connection kinds). Some underlying assumptions exist here, such as all members of the Set must be members of the Model to which this set belongs.

Figure 31. Example of a Set

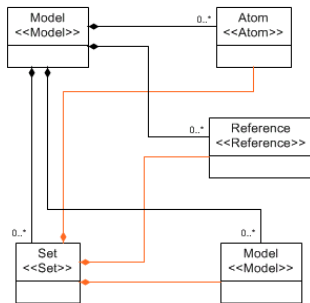

8.1.4.1. How to specify what FCO-s a Set “Owns”

Connect the *FCO* to the *Set* Atom. In the event of an ambiguity, resolve it with the *SetMembership* connection type.

Make sure to aggregate the *Set* to the *Model* in which it will reside.

8.1.5. Model

The Model may contain (through the “Containment” connection type) any other FCO, and it associates a role name to each FCO it contains. The Model has the *Name Position* and *In Root Folder* attributes.

8.1.5.1. How to contain a Model (Model-1) in a Model (Model-0)

- Connect Model-1 to Model-0

Note

It is possible to have a Model contain itself (the previous case where Model-1 == Model-0).

8.1.5.2. How to contain an Atom in a Model

In the event that an FCO is used as a superclass for the Model, then FCO may replace Model in the following sequence. Atom may be replaced by Set, Reference, or Connection.

1. Create and configure the *Atom* and the *Model*
2. Connect the *Atom* to the *Model*

8.1.6. Attributes

Attributes are represented by UML classes in the GME metamodeling environment. There are three different kinds of Attributes: Enumerated, Field, and Boolean. Once any of these Attributes are created, they are aggregated to *FCO*-s in the Attributes Aspect. The order of attributes an *FCO* will have is determined by the relative vertical location of the UML classes representing the attributes.

8.1.7. Inheritance

Inheritance is standard style for UML. Any *FCO* may inherit from an *FCO* kind of class, but an *FCO* may inherit only from other *FCO*s. Kinds may inherit only from each other (e.g. Model may not inherit from Atom). When the class is declared as abstract, then it is used during generation, but no output *FCO* is generated. No class of kind *FCO* is ever generated.

When multiple-inheritance is encountered, it will always be treated as if it were virtual inheritance. For example, the classic diamond hierarchy will result in only one grandparent class being created, rather than duplicate classes for each parent.

8.1.7.1. How to Specify Inheritance

It is assumed that Child and Parent are of the same kind (e.g. Atom, Model). *FCO* is used in this example, for brevity, but note that any *FCO* may participate in the Child role, if the Parent is of kind *FCO*. Else, they must match.

1. Connect the Parent *FCO* to the *Inheritance* Atom. This creates a superclass.
2. Connect the *Inheritance* atom to the Child *FCO*. This creates the child class.

8.1.8. Aspect

This set defines the visualization that the Models in the destination paradigm will use. Models may contain Aspects through the “HasAspect” connection kind. This is visualized using the traditional UML composition relation using a filled diamond. *FCO*s that need to be shown in the an aspect must be made members of the given Aspect set.

GME supports aspect mapping providing precise control over what aspect of a model is shown in an aspect of the containing model. This is advanced rarely-used usually feature is typically applied in case a container and a contained models have disjoint aspect sets. Specifying aspect mapping would be to cumbersome in a UML-like graphical language. The metamodeling interpreter allows specifying this information in a dialog box (described in detail later).

8.2. Composing Metamodels

The composable metamodeling environment released with GME v1.1, supports metamodel composition. First, it supports multiple paradigm sheets. Unlike most UML editors, where boxes representing classes are tied together by name, GME uses references. They are called proxies. Any UML class atom can have multiple proxies referring to it. These references are visualized by a curved arrow inside the regular UML class icon. The atom and all its proxies represent the same UML class.

8.2.1. Operators

In addition to improving the usability of the environment and the readability of the metamodels, the primary motivation behind composable metamodeling is to support the reuse of existing metamodels and, eventually, to create extensive metamodel libraries. However, this mandates that existing metamodels remain intact in the composition, so that changes can propagate to the metamodels where they are used.

The above requirement and limitations of UML made it necessary to develop three operators for use in combining metamodels together: an equivalence operator, an implementation inheritance operator, and an interface inheritance operator.

8.2.1.1. Equivalence operator

The equivalence operator is used to represent the (full) union between two UML class objects. The two classes cease to be two separate classes, but form a single class instead. Thus, the union includes all attributes and associations, including generalization, specialization, and containment, of each individual class. Equivalence can be thought of as defining the “join points” or “composition points” of two or more source metamodels.

8.2.1.2. Implementation inheritance operator

The semantics of UML specialization (i.e. inheritance) are straightforward: specialized (i.e. child) classes contain all the attributes of the general (parent) class, and can participate in any association the parent can participate in. However, during metamodel composition, there are cases where finer-grained control over the inheritance operation is necessary. Therefore, we have introduced two types of inheritance operations between class objects—implementation inheritance and interface inheritance.

In implementation inheritance, the subclass inherits all of the base class’ attributes, but only those containment associations where the base class functions as the container. No other associations are inherited. Implementation inheritance is represented graphically by a UML inheritance icon containing a solid black dot.

This can be seen in the left hand side diagram in the figure below, where implementation inheritance is used to derive class X1 from class B1. In this case, X1 the association allowing objects of type C1 to be contained in objects of type B1. In other words, X1-type objects can contain C1-type objects. Because B1-type objects can contain other B1-type objects, X1-type objects can contain objects of type B1 but not of type X1. Note that D1-type objects can contain objects of type B1 but not objects of type X1.

8.2.1.3. Interface inheritance operator

The right side of the figure shows interface inheritance between B2 and X2 (the unfilled circle inside the inheritance icon denotes interface inheritance). Interface inheritance allows no attribute inheritance but does allow full association inheritance, with one exception: containment associations where the base class functions as the container are not inherited. Therefore, in this example, X2-type objects can be contained in objects of type D2 and B2, but no objects can be contained in X2-type objects, not even other X2-type objects.

The union of implementation inheritance and interface inheritance is the normal UML inheritance. It should also be noted that these operators could have been implemented using UML stereotypes. However, interface and implementation inheritance are semantically much closer to regular inheritance than to associations. Therefore, the use of association with stereotypes would be misleading.

Figure 32. Implementation and interface inheritance operators

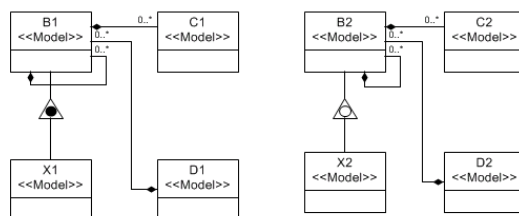

8.2.1.4. Aspect equivalence

Since classes representing Aspects show up only in the Visualization aspect, another operator is used to express the equivalence of aspects, called the SameAspect operator. While aspects can have proxies as well, they are not sets any more; they are references. Hence, they cannot be used to add additional objects to the aspect. In this case, a new aspect needs to be created. New members can be added to it, since it is a set. Using the SameAspect operator and typically a proxy of another aspect, the equivalence of the two aspects can be expressed.

Note that having two aspects with the same name without explicitly expressing the equivalence of them will result in two different aspect in the target modeling paradigm.

The name of the final aspect is determined by the following rules. If an equivalence is expressed between a proxy and a UML class, the name of the class is used. If one of them is abstract and the other is not, the name of the non-abstract class (or proxy) is used. If both aspects are proxies (or classes), then the name of the SameAspect operator is used.

Currently, the order of aspects in the target paradigm is determined by the relative vertical position of the aspect set icons in the metamodels.

8.2.1.5. Folder equivalence

The equivalence of folders can be expressed using the SameFolder operator.

8.3. Generating the Target Modeling Paradigm

Once the Paradigm Model is complete, then comes time to interpret the Model. Interpretation can be initiated from any model. After extensive consistency checking, the interpreter displays a dialog box where aspect mapping information can be specified.

8.3.1. Aspect Mapping

The dialog box contains as many tabs as there are distinct aspects in the target environment. Under each tab a listbox displays all possible model-role combinations in the first column. The second column presents the available aspects for the given model and model reference (i.e. in the specified role) in a combo box. The default selection is the aspect with the same name as the container models aspect. For all other FCOs (atoms, sets, connections) this files shows N/A.

The third column is used to specify whether the given the aspect is primary or not for the given FCO (i.e. in the specified role). In a primary aspect, the given FCO can be added or deleted. In a secondary aspect, it only shows up, but cannot be added or deleted.

Note that all the information provided by the user through this dialog box is persistent. It is stored in the metamodel, in the registry of the corresponding objects. A subsequent invocation of the interpreter will show the dialog box with the information specified by the user the previous time.

8.4. Attribute Guide

Each attribute of any given *FCO* in the Metamodeling environment has a specific meaning for the output paradigm. This section describes each attribute, and lists the *FCO(s)* in which the attribute resides. Attributes are listed by the text prompted on the screen for their entry. The section also gives what special instructions (if any) are necessary for filling out the attribute.

For fields, if the default value of the field is “”, then no default value is specified in the description. All other attributes list the default value.

1st source label	String value that gives the <i>name</i> of the Attribute class to be displayed there. The Attribute should also belong (through aggregation) to the Connection. Then, the value of that Attribute will be displayed in the first position at the end of the source of the connection. Contained in – <i>Connection</i>
2nd source label	String value that gives the <i>name</i> of the Attribute class to be displayed there. The Attribute should also belong (through aggregation) to the Connection. Then, the value of that Attribute will be displayed in the second position at the end of the source of the connection. Contained in – <i>Connection</i>
1st destination label	String value that gives the name of the Attribute class to be displayed there. The Attribute should also belong (through aggregation) to the Connection. Then, the value of that Attribute will be displayed in the first position at the end of the destination of the connection. Contained in – <i>Connection</i>
2st destination label	String value that gives the name of the Attribute class to be displayed there. The Attribute should also belong (through aggregation) to the Connection. Then, the value of that Attribute will be displayed in the second position at the end of the destination of the connection. Contained in – <i>Connection</i>
Abstract	Boolean checkbox that determines whether or not the FCO in question will actually be generated in the output paradigm. If the checkbox is checked, then no object will be created, but all properties of the FCO will be passed down to its inherited children (if any). Default value – <i>Unchecked</i> Contained in – <i>FCO, Atom, Model, Set, Connection, Reference</i>
Author Information	A text field translated into a comment within the paradigm output file. Contained in – <i>Paradigm</i>
Cardinality	Text field that gives the cardinality rules of containment for an aggregation. Default value – <i>0..*</i> Contained in – <i>Containment, FolderContainment</i>
Color	String value that gives the default color value of the connection (specified in hex, ex: 0xFF0000). Default value – <i>0x000000 (black)</i> Contained in – <i>Connection</i>

Composition role	<p>Text field that gives the rolename that the FCO will have within the Model.</p> <p>Contained in – <i>Containment</i></p>
Constraint Equation	<p>Multiline text field that gives the equation for the constraint.</p> <p>Contained in – <i>Constraint</i></p>
Context	<p>Text field that specifies the context of a Constraint Function.</p> <p>Contained in – <i>ConstraintFunc</i></p>
Data type	<p>Enumeration that gives the default data type of a FieldAttr. The possible values are String, Integer, and Double.</p> <p>Default value – <i>String</i></p> <p>Contained in – <i>FieldAttr</i></p>
Decorator	<p>Text field that specifies the decorator component to be used to display the given object in the target environment. Example: <code>MGA.Decorator.MetaDecorator</code></p> <p>Contained in – <i>Model, Atom, Reference, Set</i></p>
Default = 'True'	<p>A boolean checkbox that describes the default value of a BooleanAttr.</p> <p>Default value – Unchecked</p> <p>Contained in – <i>BooleanAttr</i></p>
Default parameters	<p>Text field that gives the default parameters of the constraint.</p> <p>Contained in – <i>Constraint</i></p>
Default menu item	<p>Text field that gives the displayed name of the menu item in the <i>Menu items</i> attribute to be used as the default value of the menu.</p> <p>Contained in – <i>EnumAttr</i></p>
Description	<p>Text field that is displayed when the constraint is violated.</p> <p>Contained in – <i>Constraint</i></p>
Displayed name	<p>String value that gives the displayed name of a Folder or Aspect. This will be the value that is shown in the model browser, or aspect tab (respectively). A blank value will result in the displayed name being equal to the name of the class.</p> <p>Contained in – <i>Folder, Aspect</i></p>
Field default	<p>Text field that gives the default value of the FieldAttr.</p> <p>Contained in – <i>FieldAttr</i></p>
General preferences	<p>Text field (multiple lines) that allows a user to enter data to be transferred directly into the XML file. This is a highly specific text</p>

area, and is normally not used. The occasions for using this area is to configure portions of the paradigm that the Metamodeling environment has not yet been developed to configure.

Contained in – *FCO, Atom, Model, Set, Connection, Reference*

Global scope

A boolean checkbox that refers to the definition scope of the attribute. In most cases, it is sufficient to leave this attribute in its default state (true). The reason for giving the option of scope is to be able to include attributes with the same names in different *FCO*-s, and have those attributes be different. In this case, it is necessary to include local scoping (i.e. remove the global scope), or the paradigm file will be ambiguous.

Default value – Checked

Contained in – *EnumAttr, BooleanAttr, FieldAttr*

Icon

Text field that gives the name of a file to be displayed as the icon for this object.

Contained in – *Atom, Set, Reference, Model*

In root folder

Boolean checkbox that determines whether or not this object can belong in the root folder. Note that if an object cannot belong to the root folder, then it must belong to a Folder or Model (somewhere in its containment hierarchy) that can belong to the root folder.

Default value – Checked

Contained in – *Folder, Model, Atom, Set, Reference*

Line end

Enumeration of the possible end types of a line. Possible types are Butt (no special end), Arrow, and Diamond.

Default value – Butt

Contained in – *Connection*

Line start

Enumeration of the possible start types of a line. Possible types are Butt (no special end), Arrow, and Diamond.

Default value – Butt

Contained in – *Connection*

Line type

Enumeration of the possible types of a line. Possible types are Solid, and Dash.

Default value – Solid

Contained in – *Connection*

Number of lines

Integer field that gives the number of lines to display for this FieldAttr.

Default value – 1

Contained in – *FieldAttr*

Menu items

A text field that lists the items in an EnumAttr. There are two modes for this text field (which can also be called a text box, because it has the ability for multiple lines).

In basic mode, the field items are separated by carriage returns, in the order in which they should be listed in the menu. In this case, the text used as the menu will be the same as value of the menu.

In the expanded mode, it is possible to list the definite values to be used for the menu elements. This is done by separating the displayed value from the actual value with a comma (,).

Example:

Figure 33. Sample enumerated attribute specification

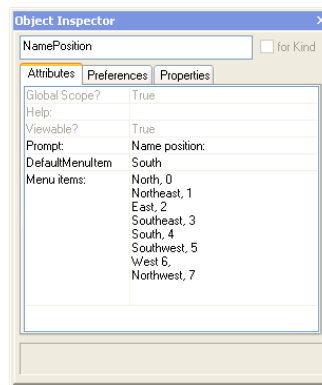

Note that the displayed and actual value need not be of the same basic type (character, integer, float, etc.) because it will all be converted to text.

Contained in – *EnumAttr*

Name position

Enumeration that lists the nine places that the name of an FCO can be displayed.

Default value – South

Contained in – *Atom, Set, Reference, Model*

Object is a port

Boolean checkbox that determines whether or not the FCO will be viewable as a port within the model.

Default value – Unchecked

Contained in – *Containment*

On...

The Constraint has many attributes which are similar, except for the type of event to which they refer. They are all boolean checkboxes that give the constraint manager the authority to check this constraint when certain events occur (e.g. Model creation/deletion, connecting two

objects). For more information on the semantics of these events, please refer to Section 10, “Constraint Manager”.

- On close model
- On new child
- On delete
- On disconnect
- On connect
- On derive
- On change property
- On change assoc.
- On exclude from set
- On include in set
- On move
- On create
- On change attribute
- On lost child
- On refer
- On unrefer

Default value – Unchecked

Contained in – *Constraint*

Port icon

Text field that gives the name of a file to be displayed as the port icon for this object. If no entry is made for this field, but the object is a port, then the normal icon will be scaled to port size.

Contained in – *Atom, Set, Reference, Model*

Priority (1=High)

Enumeration of the possible levels of priority of this constraint. For more information on constraint priority, refer to Section 10, “Constraint Manager”.

Contained in – *Constraint*

Prompt

A text field translated into the prompt of an attribute. It is in exact WYSIWYG format (i.e. no ‘:’ or ‘-’ is appended to the end).

Contained in – *EnumAttr, BooleanAttr, FieldAttr*

Return type

Text field that specifies the type a Constraint Function returns.

Contained in – *ConstraintFunc*

Rolename	<p>Text field that gives the rolename that the FCO will have in the Connection. There are two different possible default values, 'src' and 'dst', depending upon whether the connection was made from the Connector to the FCO, or the FCO to the Connector.</p> <p style="text-align: center;">Default value – src or dst</p> <p style="text-align: center;">Contained in – <i>SourceToConnector, ConnectorToSource</i></p>
Stereotype	<p>Enumeration field that specifies how a Constraint Function can be called.</p> <ul style="list-style-type: none"> • attribute • method <p style="text-align: center;">Default value – method</p> <p style="text-align: center;">Contained in – <i>ConstraintFunc</i></p>
Type displayed	<p>A boolean checkbox that decides whether the name of Type or Subtype of an Instance has to be displayed or not.</p> <p style="text-align: center;">Default value – Unchecked</p> <p style="text-align: center;">Contained in – <i>FCO, Atom, Model, Set</i></p>
TypeInfo displayed	<p>A boolean checkbox that decides whether 'T', 'S' or 'I' letter is displayed according to that the concrete model is Type, Subtype or Instance. A model does not have any sign if it is not in type inheritance.</p> <p style="text-align: center;">Default value – Checked</p> <p style="text-align: center;">Contained in – <i>Model</i></p>
Version information	<p>A text field translated into a comment within the paradigm output file. The user is responsible for updating this field.</p> <p style="text-align: center;">Contained in – <i>Paradigm</i></p>
Viewable	<p>A boolean checkbox that decides whether or not to display the attribute in the paradigm. If the state is unchecked, then the attribute will be defined in the metamodel, but not viewable in any Aspect (regardless of the properties of the FCO. This is useful if you want to store attributes outside the user's knowledge.</p> <p style="text-align: center;">Default value – Checked</p> <p style="text-align: center;">Contained in – <i>EnumAttr, BooleanAttr, FieldAttr</i></p>

8.5. Metamodeling Semantics

The following table displays the representation of the concepts of GME, and how they translate semantically into core MGA concepts.

Table 5.

First Class Objects (FCOs)		
«model»	A class	The class is an MGA model
«atom»	A class	The class is an MGA atom
«connection»	A class	The class is an MGA connection (must be used as an Association Class)
«reference»	A class	The class is an MGA reference
«set»	A class	The class is an MGA set
«FCO»	A class (abstract only)	The class is a base type of another FCO
Associations		
Containment	An association (with diamond) between a «model» and an FCO	The «model» contains the specified FCO as a part.
AssociationClass	An association between a «connection» (class) and an Association Connector (models the connection join).	The «connection» contains all of the roles that the Association Connection has.
ReferTo	A directed association between a «reference» and a «model», «atom», or «reference»	The instances of the «reference» class will refer to the instances of the «model», «atom», or «reference» class.
Association Classes		
«connection»	An association between a src/dst pair (or an n-ary connection, in the general sense) that is attributed by a «connection» class	The «connection» class represents the src/dst pair(s) as an MGA connection. [note: the «connection» is an FCO]
Containment		
FolderContainment	An association (with diamond) between a «folder» and a «folder»	The «folder» contains 0..n of the associated «folder» as a legal sub-folder
Containment	An association (with diamond) between a «model» and an FCO	The «model» contains the associated FCO which plays a specified role
SetMembership	An association (with diamond) between a «set» and an FCO	The «set» may contain the associated FCO.
HasAspect	An association between a «model» and an «aspect»	The «model» contains the specified «aspect».
Cardinality		
(none)	An integer attribute for each end of the association	This end of the association has the cardinality specified [unspecified cardinality is assumed to be 1]
Various		
«aspect»	A class	The class denotes an MGA aspect

Various		
«folder»	A class	The class denotes an MGA folder
(none)	The model represents a Project	An MGA Project
Inheritance		
(none)	UML Inheritance	The class inherits from a superclass. An attribute of the destination is the rolename to be used for the child class.
Groups of parts		
Connector	Atom, reference, (port), (reference port)	The part may play a role in a connection
FCO	Model, atom, reference, connection, set	The part is a first class object
Referenceable	Model, atom, reference	The part may be referenced

9. High-Level Component Interface

The process of accessing GME models and generating useful information, e.g. configuration files for COTS software, database schema, input for a discrete-event simulator, or even source code, is called *model interpretation*. GME provides two interfaces to support model interpretation. The first one is a COM interface that lets the user write these components in any language that supports COM, e.g. C++, Visual Basic or Java. The COM interface provides the means to access and modify the models, their attributes and connectivity. In short, the user can do everything that can be done using the GUI of the GME. There are two higher-level C++ interfaces that take care of a lot of lower level issues and makes component writing much easier. These high-level C++ component interfaces are the focus of this chapter. The first section discusses the first release of Builder Object Network, the second elaborates the more sophisticated version of BON with the Meta Object Network.

Interpreters are typical, but not the only components that can be created using this technology. The other types are *plug-ins*, i.e. components that provide some useful additional functionality to ease working in GME. These components are very similar to interpreters, though they are paradigm-independent. For example, a plug-in can be developed to search or locate objects based on some user-defined criteria, like the value of an attribute.

The third types of these components are *add-ons*, i.e. components that can react to GME-events sent by the COM Mga-Layer. These components are very useful to make GME a run-time executional environment or to write more sophisticated paradigm dependent or independent extensions.

9.1. Builder Object Network version 1.0

9.1.1. What Does the BON Do?

The component interface is implemented on the top of the COM interface. When the user initiates model interpretation, the component interface creates the so-called Builder Object Network (BON). The builder object network mirrors the structure of the models: each model, atom, reference, connection, etc. has a corresponding builder object. This way the interface shields the user from the lower level details of the COM interface and provides support for easy traversal of the models along either the containment hierarchy, the connections, or the references. The builder classes provide general-purpose functionality. The builder objects are instances of these predefined paradigm independent classes. For simple paradigm-specific or any kind of paradigm independent components, they are all the user needs. For more complicated components, the builder classes can be extended with inheritance. By using a pair of supplied macros, the user can have the component interface instantiate these paradigm-specific classes instead of the built-in ones. The builder object network will have the functionality provided by the general-purpose interface extended by the functionality the component writer needs.

9.1.2. Component Interface Entry Point

The Builder.h file in component source package defines the high-level C++ component interface. The entry point of the component is defined in the Component.h in the appropriate subdirectory of the components directory. Here is the file at the start of the component writing process:

```
#ifndef GME_INTERPRETER_H
#define GME_INTERPRETER_H

#include "Builder.h"

#define NEW_BON_INVOKE
// #define DEPRECATED_BON_INVOKE_IMPLEMENTED

class CComponent {
public:
```

```

    CComponent() : focusfolder(NULL) { ; }
    CBuilderFolder *focusfolder;
    CBuilderFolderList selectedfolders;
    void InvokeEx(CBuilder &builder, CBuilderObject *focus,
        CBuilderObjectList &selected, long param);
    // void Invoke(CBuilder &builder, CBuilderObjectList &selected, long param);
};

#endif // whole file

```

Before GME version 1.2 this used to be simpler, but not as powerful. The Invoke function of the CComponent class used to be the entry point of the component. When the user initiates interpretation, first the builder object network is created then the above function is called. The first two parameters provide two ways of traversing the builder object network. The user can access the list of folders through the CBuilder instance. Each folder provides a list of builder objects corresponding to the root models and subfolders. Any builder can then be access through recursive traversal of the children of model builders.

The CBuilderModelList contains the builders corresponding to the models selected at the time interpretation was started. If the component was started through the main window (either through the toolbar or the File menu) then the list contains one model builder, the one corresponding to the active window. If the interpretation was started through a context menu (i.e. right click) then the list contains items for all the selected objects in the given window. If the interpretation was started through the context menu of the Model Browser, then the list contains the builders for the selected models in the browser.

Using this list parameter of the Invoke function makes it possible to start the interpretation at models the user selects. The long parameter is unused at this point.

In version 1.2, Invoke has been replaced by InvokeEx, which clearly separates the focus object from the selected objects. (Depending on the invocation method both of these parameters may be empty.) To maintain compatibility with existing components, the following preprocessor constants have been designated for inclusion in the Component.h file:

- `NEW_BON_INVOKE`: if `#defined` in `Component.h`, indicates that the new BON is being used. If it is not defined (e.g. if the `Component.h` from an old BON is being used) the framework works in compatibility mode.
- `DEPRECATED_BON_INVOKE_IMPLEMENTED`: In most cases, only the `CComponent::InvokeEx` needs to be implemented by the component programmer, and the `ImgComponent::Invoke()` method of the original COM interface also results in a call to `InvokeEx`. If, however the user prefers to leave the existing `Component::Invoke()` method to be called in this case, the `#define` of this constant enables this mode. `InvokeEx()` must be implemented anyway (as `NEW_BON_INVOKE` is still defined).
- `IMPLEMENT_OLD_INTERFACE_ONLY`: this constant can be included in old `Component.h` files only to fully disable support for the `ImgComponentEx` COM interface (GME invokes to the old interface if the `InvokeEx` is not supported). Using this constant is generally not recommended.

If none of the above constants are defined, the BON framework interface is compatible with the old CComponent classes. Consequently, older BON code (`Component.h` and `Component.cpp`) can replace the corresponding skeleton/example files provided in the new BON. When using such a component, however, a warning is message is displayed to remind users to upgrade the component code to one fully compliant with the new BON. Although it is strongly recommended to update the component code (i.e. converting `CComponent::Invoke` to `CComponent::InvokeEx()`), this warning can also be suppressed by disabling the new COM component interface through the inclusion of the `#define IMPLEMENT_OLD_INTERFACE_ONLY` definition into the old `Component.h` file.

Plug-Ins are paradigm-independent components. The example Noname plug-in displays a message. The implementation is in the `component.cpp` file shown below:

```

#include "stdafx.h"
#include "Component.h"

void CComponent:: InvokeEx(CBuilder &builder,CBuilderObject *focus,
    CBuilderObjectList &selected, long param)
{
    AfxMessageBox("Plug-In Sample");
}

```

The `component.h` and `component.cpp` files are the ones that the component writer needs to expand to implement the desired functionality.

9.1.3. Component Interface

Figure 34. Class diagram of Builder Object Network

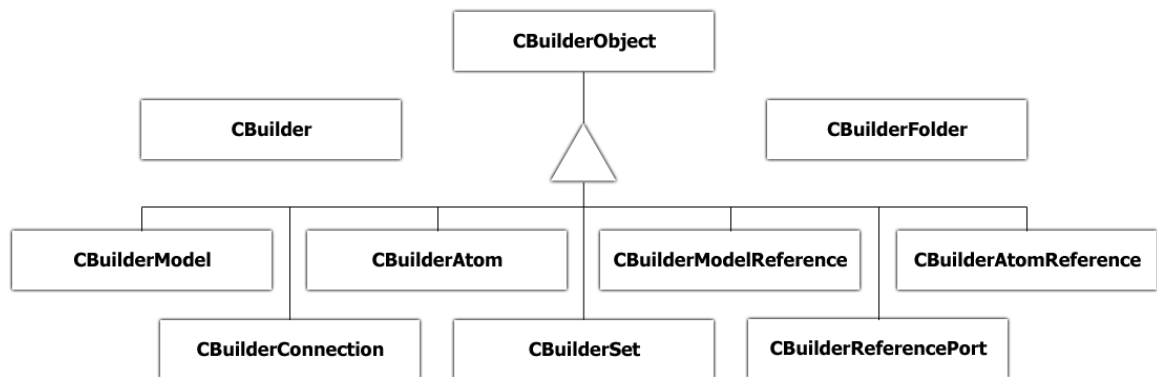

The simple class structure of the component interface is shown below. Note that each class is a derivative of the standard MFC `CObject` class.

As noted before, the single instance of the `CBuilder` class provides a top level entry point into the builder object network. It provides access to the model folders and supplies the name of the current project. The public interface of the `CBuilder` class is shown below.

```

class CBuilder : public CObject {
public:
    CBuilderFolder *GetRootFolder() const;
    const CBuilderFolderList *GetFolders() const;
    CBuilderFolder *GetFolder(CString &name) const;
    CString GetProjectName() const;
};

```

The `CBuilderFolder` class provides access to the root models of the given folder. It can also be used to create new root models.

```

class CBuilderFolder : public CObject {
public:
    const CString& GetName() const;
    const CBuilderModelList *GetRootModels() const;
    const CBuilderFolderList *GetSubFolders() const;
    CBuilderModel *GetRootModel(CString &name) const;
    CBuilderModel *CreateNewModel(CString kindName);
};

```

The `CBuilderObject` is the base class for several other classes. It provides a set of common functionality for models, atoms, references, sets and connections. Some of the functions need some explanation.

The `GetAttribute()` functions return true when their successfully retrieved the value of attribute whose name was supplied in the name argument. If the type of the val argument does not match the attribute or the wrong name was provided, the function return false. For field and page attributes, the type matches that of specified in the meta, for menus, it is a `CString` and for toggle switches, it is a `bool`.

The `GetxxxAttributeNames` functions return the list of names of attributes the given object has. This helps writing paradigm-independent components (plug-ins).

The `GetReferencedBy` function returns the list of references that refer to the given object (renamed in v1.2 from `GetReferences`).

The `GetInConnections` (`GetOutConnection`) functions return the list of incoming (outgoing) connections from the given object. The string argument specifies the name of the connection kind as specified by the modeling paradigm. The `GetInConnectedObjects` (`GetOutConnectedObjects`) functions return a list of objects instead. The `GetDirectInConnections` (`GetDirectOutConnections`) build a tree. The root of the tree is the given object, the edges of the tree are the given kind of connections. The function returns the leaf nodes. Basically these functions find paths to (from) the given object without the component writer having to write the traversal code.

The `TraverseChildren` virtual functions provide a ways to traverse the builder object network along the containment hierarchy. The implementation provided does not do anything, the component writer can override it to implement the necessary functionality. As we'll see later, the `CBuilderModel` class does override this function. It enumerates all of its children and calls their `Traverse` method.

```
class CBuilderObject : public CObject {
    const CString& GetName();
    const bool SetName(CString newname);

    void GetNamePath(CString &namePath) const
    const CString& GetKindName() const;
    const CString& GetPartName() const;

    const CBuilderModel *GetParent() const;
    CBuilderFolder* GetFolder() const;

    bool GetLocation(CString &aspectName,CRect &loc);
    bool SetLocation(CString aspectName,CPoint loc);
    void DisplayError(CString &msg) const;
    void DisplayError(char *msg) const;
    void DisplayWarning(CString &msg) const;
    void DisplayWarning(char *msg) const;
    bool GetAttribute(CString &name,CString &val) const;
    bool GetAttribute(char *name,CString &val) const;
    bool GetAttribute(CString &name,int &val) const;
    bool GetAttribute(char *name,int &val) const;
    bool GetAttribute(CString &name,bool &val) const;
    bool GetAttribute(char *name,bool &val) const;
    bool SetAttribute(CString &name, CString &val);
    bool SetAttribute(CString &name, int val);
    bool SetAttribute(CString &name, bool val);
    void GetStrAttributeNames(CStringList &list) const;
    void GetIntAttributeNames(CStringList &list) const;
    void GetBoolAttributeNames(CStringList &list) const;
    void GetReferencedBy(CBuilderObjectList &list) const;
    const CBuilderConnectionList *GetInConnections(CString &name) const;
    const CBuilderConnectionList *GetInConnections(char *name) const;
    const CBuilderConnectionList *GetOutConnections(CString name) const;
    const CBuilderConnectionList *GetOutConnections(char *name) const;

    bool GetInConnectedObjects(const CString &name, CBuilderObjectList &list);
    bool GetInConnectedObjects(const char *name, CBuilderObjectList &list);
    bool GetOutConnectedObjects(const CString &name, BuilderObjectList &list);
```

```

bool GetOutConnectedObjects(const char *name, CBuilderObjectList &list);

bool GetDirectInConnections(CString &name, CBuilderObjectList &list);
bool GetDirectInConnections(char *name, CBuilderObjectList &list);
bool GetDirectOutConnections(CString &name, CBuilderObjectList &list);
bool GetDirectOutConnections(char *name, CBuilderObjectList &list);

virtual void TraverseChildren(void *pointer = 0);
};

```

The `CBuilderModel` class is the most important class in the component interface, simply because models are the central objects in the GME. They contain other objects, connections, sets, they have aspects etc. The `GetChildren` function returns a list of all children, i.e. all objects the model contains (models, atoms, sets, references and connections). The `GetModels` method returns the list of contained models. If a role name is supplied then only the specified part list is returned. The `GetAtoms`, `GetAtomReferences` and `GetModelReferences`, `GetSets()` functions work the same way except that a part name must be supplied to them. The `GetConnections` method return the list of the kind of connections that was requested. These are the connections that are visible inside the given model.

The `GetAspectNames` function return the list of names of aspects the current model has. This helps in writing paradigm-independent components.

Children can be created with the appropriate creation functions. Similarly, connections can be constructed by specifying their kind and the source and destination objects. Please, see the description of the `CBuilderConnection` class for a detailed description of connections.

The `TraverseModels` function is similar to the `TraverseChildren` but it only traverses models.

```

class CBuilderModel : public CBuilderObject {
public:
    const CBuilderObjectList *GetChildren() const;
    const CBuilderModelList *GetModels() const;
    const CBuilderModelList *GetModels(CString partName) const;
    const CBuilderAtomList *GetAtoms(CString partName) const;
    const CBuilderModelReferenceList *GetModelReferences( CString refPartName) const;
    const CBuilderAtomReferenceList *GetAtomReferences( CString refPartName ) const;
    const CBuilderConnectionList *GetConnections(CString name) const;
    const CBuilderSetList *GetSets(CString name) const;

    void GetAspectNames(CStringList &list);

    CBuilderModel *CreateNewModel(CString partName);
    CBuilderAtom *CreateNewAtom(CString partName);
    CBuilderModelReference *CreateNewModelReference(CString refPartName, CBuilderObject*
refTo);
    CBuilderAtomReference *CreateNewAtomReference(CString refPartName, CBuilderObject*
refTo);
    CBuilderSet *CreateNewSet(CString partName);
    CBuilderConnection *CreateNewConnection(CString connName, CBuilderObject *src,
CBuilderObject *dst);

    virtual void TraverseModels(void *pointer = 0);
    virtual void TraverseChildren(void *pointer = 0);
};

```

The `CBuilderAtom` class does not provide any new public methods.

```

class CBuilderAtom : public CBuilderObject {
public:
};

```

The `CBuilderAtomReference` class provides the `GetReferred` function that returns the atom (or atom reference) referred to by the given reference.

```

class CBuilderAtomReference : public CBuilderObject {

```

```

    const CBuilderObject *GetReferred() const;
};

```

Even though the GME deals with ports of models (since models cannot be connected directly, these are the objects that can be), the component interface avoids using ports for the sake simplicity. However, model references mandate the introduction of a new kind of object, model reference ports. A model reference contains a list of port objects. The `GetOwner` method of the `CBuilderReferencePort` class return the model reference containing the given port. The `GetAtom` method returns the atom that corresponds to the port of the model that the model reference port represents.

```

class CBuilderReferencePort : public CBuilderObject {
public:
    const CBuilderModelReference *GetOwner() const;
    const CBuilderAtom *GetAtom() const;
};

```

The `CBuilderModelReference` class provides the `GetReferred` function that returns the model (or model reference) referred to by the given reference. The `GetRefereePorts` return the list of `CBuilderReferencePorts`.

```

class CBuilderModelReference : public CBuilderObject {
    const CBuilderReferencePortList &GetRefereePorts() const;
    const CBuilderObject *GetReferred() const;
};

```

A `CBuilderConnection` instance describes a relation among three objects. The owner is the model that contains the given connection (i.e. the connection is visible in that model). The source (destination) is always an atom or a reference port. If it is an atom then it is either contained by the owner, or it corresponds to a port of a model contained by the owner. So, in case of atoms, either the source (destination) or its parent is a child of the owner. In case of a reference port, its owner must be a child of the owner of the connection.

```

class CBuilderConnection : public CBuilderObject {
public:
    CBuilderModel *GetOwner() const;
    CBuilderObject *GetSource() const;
    CBuilderObject *GetDestination() const;
};

```

The `CBuilderSet` class member function provide straightforward access to the different components of sets.

```

class CBuilderSet : public CBuilderObject {
public:
    const CBuilderModel *GetOwner() const;
    const CBuilderObjectList *GetMembers() const;

    bool AddMember(CBuilderObject *part);
    bool RemoveMember(CBuilderObject *part);
};

```

9.1.4. Example

The following simple paradigm independent interpreter displays a message box for each model in the project. For the sake of simplicity, it assumes that there is no folder hierarchy in the given project. The component `.cpp` file is shown below.

```

#include "stdafx.h"
#include "Component.h"

void CComponent:: InvokeEx(CBuilder &builder, CBuilderObject *focus,
    CBuilderObjectList &selected, long param)
{
    const CBuilderFolderList *folds = builder.GetFolders();
    POSITION fPos = folds->GetHeadPosition();

```

```

while(fPos) {
    CBuilderFolder *fold = folds->GetNext(fPos);
    const CBuilderModelList *roots = fold->GetRootModels();
    POSITION rootPos = roots->GetHeadPosition();
    while(rootPos)
        ScanModels(roots->GetNext(rootPos), fold->GetName());
}
}

void CComponent::ScanModels(CBuilderModel *model, CString fName)
{
    AfxMessageBox(model->GetName() + " model found in the " +
        fName + " folder");

    const CBuilderModelList *models = model->GetModels();
    POSITION pos = models->GetHeadPosition();
    while(pos)
        ScanModels(models->GetNext(pos), fName);
}

```

9.1.5. Extending the Component Interface

The previous example used the built-in classes only. The component writer can extend the component interface by her own classes. In order for the interface to be able to create the builder object network instantiating the new added classes before the user defined interpretation actually begins, a pair of macros must be used.

The derived class declaration must use one of the DECLARE macros. The implementation must include the appropriate IMPLEMENT macro. There is a pair of macros for models, atoms, model- and atom references, connections and sets. The following list describes their generic form.

```

DECLARE_CUSTOMMODEL(<CLASS>, <BASE CLASS>)
DECLARE_CUSTOMMODELREF(<CLASS>, <BASE CLASS>)
DECLARE_CUSTOMATOM(<CLASS>, <BASE CLASS>)
DECLARE_CUSTOMATOMREF(<CLASS>, <BASE CLASS>)
DECLARE_CUSTOMCONNECTION(<CLASS>, <BASE CLASS>)
DECLARE_CUSTOMSET(<CLASS>, <BASE CLASS>)

IMPLEMENT_CUSTOMMODEL(<CLASS>, <BASE CLASS>, <NAMES>)
IMPLEMENT_CUSTOMMODELREF(<CLASS>, <BASE CLASS>, <NAMES>)
IMPLEMENT_CUSTOMATOM(<CLASS>, <BASE CLASS>, <NAMES>)
IMPLEMENT_CUSTOMATOMREF(<CLASS>, <BASE CLASS>, <NAMES>)
IMPLEMENT_CUSTOMCONNECTION(<CLASS>, <BASE CLASS>, <NAMES>)
IMPLEMENT_CUSTOMSET(<CLASS>, <BASE CLASS>, <NAMES>)

```

Here, the <CLASS> is the name of the new class, while the <BASE_CLASS> is the name of one of the appropriate built-in class or a user-derived class. (The user can create abstract base classes as discussed later.) The <NAMES> argument lists the names of the kinds of models the given class will be associated with. It can be a single name or a comma separated list. The whole names string must be encompassed by double quotes.

For example, if we have a "Compound" model in our paradigm, we can create a builder class for it the following way.

```

// Component.h

class CCompoundBuilder : public CBuilderModel
{
    DECLARE_CUSTOMMODEL(CCompoundBuilder, CBuilderModel)
public:
    virtual void Initialize();
    virtual ~CCompoundBuilder();

    // more declarations

```



```

};

// Component.cpp

IMPLEMENT_CUSTOMMODEL(CCompoundBuilder, CBuilderModel, "Compound")

void CCompoundBuilder::Initialize()
{
    // code that otherwise would go into a constructor

    CBuilderModel::Initialize();
}

CCompoundBuilder::~CCompoundBuilder()
{
    // the destructor
}
// more code

```

The macros create a constructor and a Create function in order for a factory object to be able to create instances of the given class. Do not define your own constructors, use the `Initialize()` function instead. You have to call the base class implementation. These macros call the standard MFC `DECLARE_DYNCREATE` and `IMPLEMENT_DYNCREATE` macros.

If you want to define abstract base classes that are not associated with any of your models, use the appropriate macro pair from the list below. Note that the `<NAMES>` argument is missing because there is no need for it.

```

DECLARE_CUSTOMMODELBASE(<CLASS>, <BASE CLASS>)
DECLARE_CUSTOMMODELREFBASE(<CLASS>, <BASE CLASS>)
DECLARE_CUSTOMATOMBASE(<CLASS>, <BASE CLASS>)
DECLARE_CUSTOMATOMREFBASE(<CLASS>, <BASE CLASS>)
DECLARE_CUSTOMCONNECTIONBASE(<CLASS>, <BASE CLASS>)
DECLARE_CUSTOMSETBASE(<CLASS>, <BASE CLASS>)

IMPLEMENT_CUSTOMMODELBASE(<CLASS>, <BASE CLASS>)
IMPLEMENT_CUSTOMMODELREFBASE(<CLASS>, <BASE CLASS>)
IMPLEMENT_CUSTOMATOMBASE(<CLASS>, <BASE CLASS>)
IMPLEMENT_CUSTOMATOMREFBASE(<CLASS>, <BASE CLASS>)
IMPLEMENT_CUSTOMCONNECTIONBASE(<CLASS>, <BASE CLASS>)
IMPLEMENT_CUSTOMSETBASE(<CLASS>, <BASE CLASS>)

```

For casting, use the `BUILDER_CAST(CLASS, PTR)` macro for casting a builder class pointer to its derived custom builder object pointer.

9.1.6. Example

Let's assume that our modeling paradigm has a model kind called Compound. Let's write a component that implements an algorithm similar to the previous example. In this case, we'll scan only the Compound models. Again, the folder hierarchy is not considered. Here is the `Component.h` file:

```

#ifndef GME_INTERPRETER_H
#define GME_INTERPRETER_H

#include "Builder.h"

#define NEW_BON_INVOKE
// #define DEPRECATED_BON_INVOKE_IMPLEMENTED

class CComponent {
public:
    CComponent() : focusfolder(NULL) { ; }
    CBuilderFolder *focusfolder;
    CBuilderFolderList selectedfolders;
    void InvokeEx(CBuilder &builder, CBuilderObject *focus,

```

```

    CBuilderObjectList &selected, long param);
};

class CCompoundBuilder : public CBuilderModel
{
    DECLARE_CUSTOMMODEL(CCompoundBuilder, CBuilderModel)
public:
    void Scan(CString foldName);
};

#endif // whole file

```

The component .cpp file is shown below.

```

#include "stdafx.h"
#include "Component.h"

void CComponent::InvokeEx(CBuilder &builder, CBuilderObject *focus,
    CBuilderObjectList &selected, long param)
{
    const CBuilderFolderList *folds = builder.GetFolders();
    POSITION foldPos = folds->GetHeadPosition();
    while(foldPos) {
        CBuilderFolder *fold = folds->GetNext(foldPos);
        const CBuilderModelList *roots = fold->GetRootModels();
        POSITION rootPos = roots->GetHeadPosition();
        while(rootPos) {
            CBuilderModel *root = roots->GetNext(rootPos);
            if(root->IsKindOf(RUNTIME_CLASS(CCompoundBuilder)))
                BUILDER_CAST(CCompoundBuilder, root)->Scan(fold->GetName());
        }
    }
}

IMPLEMENT_CUSTOMMODEL(CCompoundBuilder, CBuilderModel, "Compound")

void CCompoundBuilder::Scan(CString foldName)
{
    AfxMessageBox(GetName() + " model found in " + foldName +
        " folder");

    const CBuilderModelList *models = GetModels("CompoundParts");
    POSITION pos = models->GetHeadPosition();
    while(pos)
        BUILDER_CAST(CCompoundBuilder, models->GetNext(pos))->Scan(foldName);
}

```

9.2. Meta Object Network

9.2.1. What is MON?

Using the previous version of BON the users experienced that lots of implementation issues could be solved more simply if they had a simple and well-defined interface to the metamodel of their domains. The MON makes the paradigm available at the time of writing components. All information covered by the metamodel are accessible (from the aspect and valid connections between objects to constraints).

The benefits are obvious:

- MON is the key to write paradigm-independent interpreters or plug-ins to GME avoiding to get into the details of COM.
- For a user the definition of a GME metamodel sometimes could be very difficult to understand. With MON GME developers and interpreter writers can examine the wellness of the paradigm easily and may get more familiar with rules how a GME paradigm is specified and interpreted.

- It made possible to implement BON2 on the base of well-specified interface. BON2 is developed on the basis of MON and it depends tightly to the classes defined in MON, as you can see in the latter subsections.
- References to a metaobject can be done with the metaobject itself eliminating the mistakes came from misspelled names for example.

Whenever GME or the users execute a component, the paradigm is always accessible to the component via MON. The meta object network is read-only, and can be altered indirectly with reinterpretation only (or modifying manually the .xmp file containing the interpreted metamodel).

The meta object network is created during the initialization time of the components and it is already readable when the user's initialization code runs.

Note

The time of the creation of the specific MON may be a couple of seconds depending of the complexity of the paradigm.

9.2.2. Basic MON Classes

The next figure shows clearly the inheritance chain between the core classes of MON.

Figure 35. MON classes, which have corresponding COM interfaces

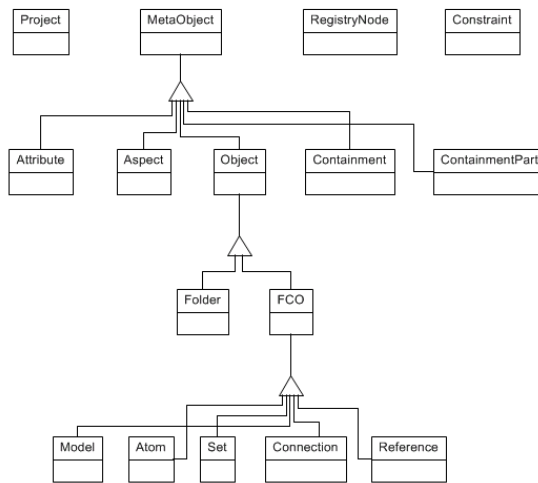

MetaObject is the base class for all classes whose instances have unique identifier (MetaReferenceID). This MON class corresponds to the IMgaMetaBase COM interface which has common meta properties (identifier - mentioned above, name – string identifier, displayed name).

Among the basic classes there are only three which do not have ancestors:

- Project corresponds to the IMgaMetaProject which is the root of the object network. Because it contains directly or indirectly all metaobjects (i.e. all MON classes have the method `project()` to access the project), Project offers methods with which the user can obtain all instances of a specific metakind or a meta-relation and he can find the MetaObject correspondent to a MetaReferenceID, to the name of a metakind or to name of an Aspect.
- RegistryNode corresponds to the IMgaMetaRegNode COM interface which is simply a name-value pair with the extension that the nodes are organized into a tree called Registry. A MetaObject

always has this Registry, even it is absolutely empty. For the sake of clarity the `MetaObject`'s `registry()` returns a dummy `RegistryNode` object from which all 'root' nodes may be accessed.

- `Constraint` is associated with class `Object`. `Object` corresponds to metakind, i.e. `Folder`, `FCO` and descendants of `FCO`. This class is introduced only by `MON`, it does not have the appropriate `COM` interface.

The unmentioned classes will be discussed in the following subsections.

9.2.3. Meta-Kinds in MON

In this subsection the meta-kinds and their specific relationships are discussed. These meta-kinds are the following: `Folder` and `FCO` which is the base of `Atom`, `Model`, `Connection`, `Set` and `Reference`. In the context of UML these meta-kinds are stereotypes denoting what kind of relationships they can take part in.

These are shown in the next figure without the meta-kind `Atom`, because this concept means a simple, undividable entity (class in UML) which does not have any special and additional properties that `FCO` has.

`Folder` is similar to package or namespace but comparing with the package concept in UML, in the same paradigm more than one `Folder` may exist (they can contain different kinds). Because of this fact, each folder can have different semantics and they are considered as kinds and must have unique names with `fcos`.

In GME Model is the most important concept, because it specifies with `Containment` the hierarchical structure of the objects in a GME project. As it is shown in the figure, `Containment` is a `Model-FCO` pair with a unique name in the context of the `Model`. In contrast to UML, regarding the relationships instead of class GME deals with `Containment` which corresponds to the containment role and `ImageMetaRole` `COM` interface. With this concept more sophisticated paradigms may be created without further constraints (e.g. in a class only that student may take part in a golf club whose all grades are 'A' – `Class ~ Model`, `Student ~ FCO`, `Excellent ~ Containment` `GolfClub ~ Set`) That is why `Set` and `Reference` are associated with `Containment` instead of `FCO`. These associations similarly to `FolderContainment` are blue colored denoting that they are introduced only in `MON`.

Figure 36. MON classes with their specific relations

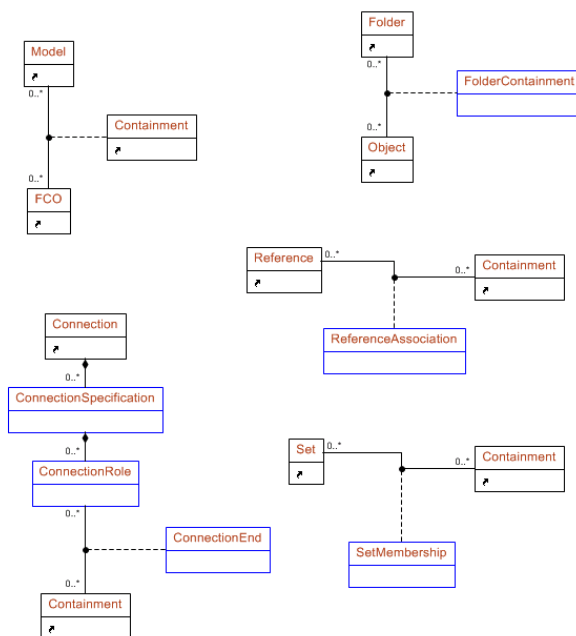

Connection is more complicated than Reference or a Set. The meaning of the classes is described well with a bidirectional connection in whose case a connection has two specifications regarding the two directions how two containment (usually fcos with their all containments) can be connected. In the metamodeling environment only binary connections can be created with src and dst ConnectionRole. Except of Connection and Containment all classes are blue-colored because COM objects cannot be assigned to the instances unambiguously.

9.2.4. Specific GME Concepts

Via MON all information related with aspects can be obtained. ModelInAspect association describes which Model in which Aspect can be opened in the model editor. ContainmentPart, which corresponds to IMgaMetaPart COM interface, tells the user which containment roles are visible in the particular aspect.

Figure 37. Relationships of Attributes, Aspects, RegistryNodes and Constraints

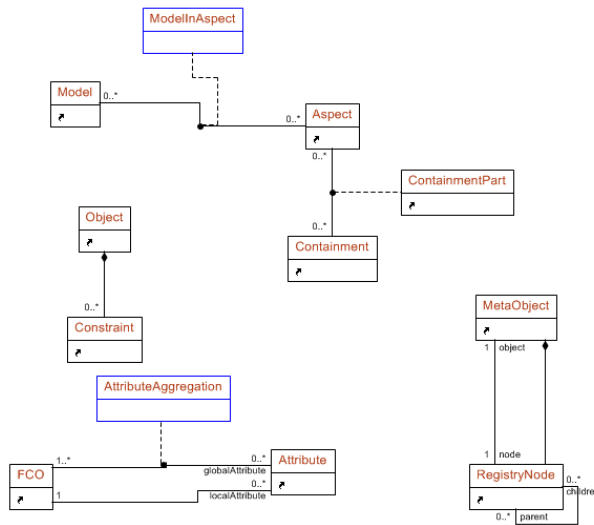
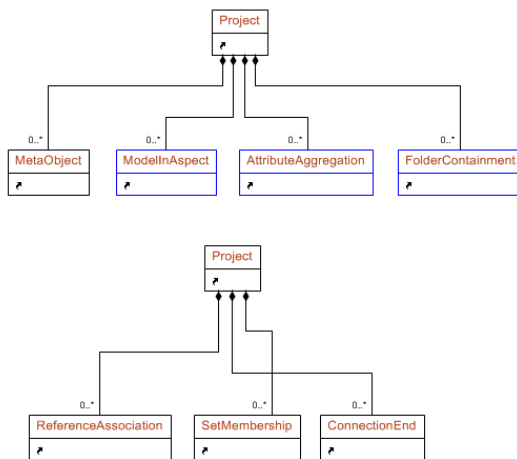

Figure 38. How the MetaProject relates to other classes



In GME there are two kind of attributes, local and global attributes. Local attributes are defined directly in the context of an fco. Global ones may be associated with more than one fco (`AttributeAggregation`).

`Constraint` is contained by `Object` which corresponds to metakind and the last concept is the `RegistryNode` mentioned earlier.

That is shown in the last figure `Project` contains `MetaObject` and all associations which mean many-many relationships between metaobjects.

9.2.5. How to Use Mon

We mentioned earlier BON2 is based on MON thus it is obvious there are a lot of similarities between the two object networks. Because for an interpreter writer the architecture of BON2 is more important than MON, we will mention the specific usage and differences during the discussion of BON2.

9.3. Builder Object Network version 2.0

9.3.1. Architecture of BON2

For a user to use and extend BON2 appropriately, she must understand the architecture and the essential concepts implemented by default in the object network. When somebody would like to write an interpreter, she wants to do it as fast as it is possible, she does not want to deal with typical programming issues (i.e. object disposal, complexity of COM, etc.), and she would like to face only the domain-specific task. If an interpreter writer follows the rules discussed in these subsections and she is familiar with GME, she has to know almost nothing about C++ and COM to achieve the goal simply and very fast.

BON2 defines three layers (four layers) based on each other:

- COM layer (0. layer) – This is the programmable interface of GME, the lowest layer which should be absolutely hidden from the user because of its complexity, and, in the case of interpreters, the superfluous knowledge of how to use COM properly. Correspondent files are `meta.idl`, `mga.idl`. Example: `IMgaFCO` COM interface.
- Implementation layer (1.a. layer) – This layer is the core of BON2 in which all easy-to-use calls using MON are translated into COM operations. This is the place where BON objects are cached and where the basics of BON2 extensions are implemented. Correspondent files are `MONImpl.h`, `BONImpl.h`. Example: `BON::FCOImpl` implementation class.
- Interface layer (1.b. layer) – This consists of the classes and operations which are exported to the user (i.e. they have public visibility). These are discussed in the Appendix concerning MON and BON. Currently, this layer is built into the previous one. Correspondent files are `MON.h`, `BONImpl.h`. Example: `BON::FCOImpl`.
- Wrapper layer (2. layer) – The top most layer consists of the wrappers which handle the object references and provides a pointer-like interface. When a user uses BON2, she always has to deal with these classes. Correspondent files are `MON.h`, `BON.h`. Example: `BON::FCO` wrapper class.

9.3.2. Wrapper Classes

The wrappers are created in order to make interpreter writing easier.

First of all, wrappers should be considered as special pointers (i.e. *smart pointers*) which hold a pointer to a real object. If all (direct or indirect) references to the real object are released, the object is disposed of

automatically. It is recommended to use this automatic mechanism instead of a manual garbage collection scheme.

BON2 wrapper classes use the operator `->` to access functionality, in contrast to MON wrappers which use the simple operator `.` Here is an example:

```
BON::FCO fco; // Here is an fco.
// fco.isPort( ); // This would result a compiler error because the wrapper does not
// have this operation.
fco->isPort( ); // The operator[->] dereferences a BON::FCOImpl pointer.
MON::FCO metafco = fco->getFCOMeta(); // obtain the definition of the FCO.
std::string strKindName = metafco.name(); // get the name of the meta, the kindname of
the object
```

Important

Although advanced programmers may get the pointer of the implementation object and store it outside of wrappers, it is not recommended, because they have to be sure somehow the pointer is valid and not disposed already. With the wrappers, validity of a BON object can be determined by operator[bool] and operator[!].

```
BON::Project project; // Let's assume the project is valid.
BON::Folder root = project->getRootFolder( ); // Get the root folder
if ( root ) AfxMessageBox( "RootFolder always exists!" );
BON::Folder parent = root->getParentFolder(); // Get the parent of the root, which is
NULL.
if ( ! parent ) AfxMessageBox( "RootFolder never has parent" );
```

The user can check the equality of two BON objects with the operator[==] and operator[!=]. It must be emphasized that this equality means that the two COM objects are equal, not (necessarily) the wrappers. It is not necessary to obtain the implementation pointers to check whether two objects are equal or not. The operator[<] makes it possible for the objects to be included into any kind of STL container, including sets and maps. These operators can be used for all BON objects (e.g. `BON::Project` is comparable with `BON::ReferencePort`).

The last important feature of wrappers is the casting mechanism. This is implemented via the copy constructors and assignment operators. If the cast succeeds, then the pointer held by the appropriate wrapper will be valid, otherwise it will be null. To understand this, let's see the following example.

```
BON::Model child; // Let's assume child is valid
BON::Object parent = child->getParent();
if ( parent ) AfxMessageBox( "This is always valid" );
BON::Model model = object;
if ( model ) AfxMessageBox( "The parent is a model" );
if ( BON::Folder( object ) ) AfxMessageBox( "The parent is a folder" );
```

These facilities are implemented in the wrapper classes. For details see the Appendix about BON invocations and classes.

9.3.3. Objects' Lifecycle in Components

The user does not have to deal with the construction and destruction of BON objects. However it is good to know how it is implemented and what the guidelines are.

A BON object is always created the first time the user obtains a reference to a COM entity. In most cases, an instance of a BON implementation class is assigned to the appropriate COM object and the BON object is cached.

More than one BON object may be assigned to the same COM object. The wrappers have the responsibility to decide when a BON object must be erased from the cache.

The time of disposal of objects depends on two essential factors:

- the component's type.
- the number of references to a BON implementation object.

Note

The whole meta object network (all MON objects) is created when the component starts to run and it is destructed when the component accomplishes its task.

9.3.3.1. Objects in Add-ons and in Interpreters

The time when objects are freed differs in the case of add-ons and interpreters (plug-ins are regarded here as paradigm-independent interpreters). The difference is based on the typical process of the components.

As we mentioned above, BON objects are created if and only if they are required to be constructed (i.e. the first time COM objects are retrieved), in contrast with the previous version of BON, where the whole project was mirrored and all BON objects were created at the time of the component initialization.

When the user writes an interpreter it is likely that she would like to use an object more than once and she would like to eliminate the time consumed by repeated construction and destruction. Thus, in case of interpreters, a BON object is cached (remains in the memory) until the component finishes running. In short, if an object is retrieved, it will not be disposed even if there are no references to it.

Add-ons associated with a project run and occupy memory the whole time until the project is closed. If we followed the previous rule of managing objects, the memory would grow while the add-on runs. Therefore in case of add-ons, a BON object is immediately destructed after the last direct or indirect reference is released.

9.3.3.2. Aggregated Reference-counting

As we mentioned earlier wrapper classes are smart pointers; they manage the references to an object and dispose a BON implementation instance if the last reference is released. If you extend BON classes, take care not introduce reference cycles, as the memory can never be reclaimed unless the references are manually set to `null`. This is typically done during finalization.

9.3.4. Extending Interpreters

The lifecycle of GME components is the same. After they are initialized, they start to run, do their tasks and terminate, disposing of the acquired resources.

During the initialization all additional resources of the component of the user must be obtained and created. This can be done completed the `initialize()` method of `BON::Component` class. When this code part runs, the singleton project for the `IMgaProject` and the whole meta object network are already created.

During the finalization all resources must be released. The process of disposal consists of the destruction of all BON and MON objects (releasing all references to BON objects) and releasing any additional resources (database connections, etc.). This can in the `finalize()` operation of `BON::Component`.

The steps of finalization are the following (these are done automatically):

- Call `finalize()` of `BON::Component`.
- Iterate over the set of the existing BON objects and call their `finalize()`.

- The reference counting mechanism takes care of the BON objects' disposal, and everything is destructed.

Where the component core implementation must be included is different in case of add-ons and interpreters.

The interpreters' entry point is the `invokeEx()` of `BON::Component` and this is the main part. Here is a descriptive example:

```
void Component::invokeEx( Project& project, FCO& currentFCO, const std::set<FCO>&
    setSelectedFCOs, long lParam )
{
    AfxMessageBox( "Project: " + CString( project->getName().c_str() ) );
    if ( ! Model( currentFCO ) ) {
        AfxMessageBox( "The context of the component must be a model!" )
        return;
    }
    CString strObjects( "Selected objects are: \r\n" );
    for ( std::set<FCO>::iterator it = setSelectedFCOs.begin() ; it !=
        setSelectedFCOs.end() ; it++ ) {
        strObjects += CString( (*it)->getName().c_str() ) + "\r\n" );
    }
    AfxMessageBox( strObjects );
} // end of invokeEx
```

9.3.5. Add-ons and Events

The entry point of an add-on means the reaction to the specific event of a specific object and it can be accomplished in different ways.

The user may handle and react to all events in `objectEventPerformed()` of `BON::Component`. Here is an example:

```
void Component::objectEventPerformed( Object& object, unsigned long event, VARIANT v )
{
    // v in this version of BON2 is unused, in the future it will contain
    // appropriate event parameter(s)
    AfxMessageBox( "The context: " + CString( object->getName().c_str() ) );
    // At the same time more than one event may be performed.
    CString strEvents( "Events: \r\n" );
    for ( MON::ObjectType eType = MON::OET_ObjectCreated ; eType != MON::OET_All ;
        eType++ ) {
        strEvents += CString( toString( eType ).c_str() ) + "\r\n";
    }
    AfxMessageBox( strEvents );
}
```

This way of handling events is the most general. It is likely the user may prefer the `BON::EventListener` interface. This interface has the `eventPerformed()` operation which is empty by default. The operation only has a `BON::Event` argument containing the context object, the event type, and the event parameters (if they exist).

The `BON::EventListener` interface must be implemented by a class, and an instance of the class has to be passed to the BON project or to a BON object `addEventListener()` operation. An event listener may specify the type of the events it can react to. It can be done with overriding the `getAssignments()` operation of the listener (it reacts to all events by default).

The order of event handling:

- EventListeners attached to the project are called if they active.
- EventListeners attached to the context object are called if they active.

- `objectEventPerformed()` of the `BON::Component` is called.

9.3.6. BON Extension Classes

So that the user can write an interpreter which is simple enough to create and modify, the BON2 provides an easy-to-use base. The generic implementation (i.e. `BON::FCO` and `BON::FCOImpl`) may be extended to accommodate a specific paradigm.

The extendable classes are `BON::FCO`, `BON::Atom`, `BON::Model`, `BON::Connection`, `BON::Set` and `BON::Reference`. Of course a user extension can be extended also.

We will demonstrate the extension with a simple example. Let us assume that there is a model whose name is ‘Compound’ and the user wants to create a BON class which extends the model’s functionality with an operation. The operation returns a set containing Compound objects having at least two children.

9.3.6.1. Creating the Implementation Class

The creation of a BON extension must be done in the extension layer (i.e. the implementation class must be derived). In order to do this the following rules are important:

- Although the implementor extends the implementation class, the user must always use the appropriate wrapper classes, and not the implementations.
- If some initialization is required, then the `initialize()` method must be overridden.
- In case of interpreters, there is no point in caching the result of a generic call because only the lightweight wrappers are created.
- If BON objects are cached by the extension, it counts as an additional reference. The containers must be emptied and objects must be set to null in the overridden `finalize()` method.
- It is good practice to concatenate ‘Impl’ string to the name of the implementation class. The appropriate wrapper class uses the name without ‘Impl’.

Here is our Compound implementation:

```
class CompoundImpl
: public BON::ModelImpl // extending the implementation class
{
public :
void initialize()
{
// cache the proper child models
std::set<BON::Model> temp = getChildModels();
for ( std::set<BON::Model>::iterator it = temp.begin() ;
it != temp.end() ; it++ ) {
if ( (*it)->getObjectMeta().name() == "Compound" &&
(*it)->getChildFCOs().size() >= 2 ) {
mySet.insert( *it );
}
}
}

void finalize()
{
mySet.clear(); // important to avoid reference cycles
}

std::set<BON::Model> getMyCompounds()
{
return mySet;
}
```

```

    }

private :
    std::set<BON::Model> mySet;

}; // end of class

```

9.3.6.2. Create the Wrapper Class

After the implementation is ready, the user has to generate an appropriate wrapper class to the implementation class and assign it to a specific kind defined by the paradigm. These correspond to two macros: `DECLARE_BONEXTENSION` and `IMPLEMENT_BONEXTENSION`.

`DECLARE_BONEXTENSION` macro creates the appropriate wrapper. It must precede the macros defining the classes which derive from this class. The parameters are the following:

- Base wrapper class – This class has to be the wrapper class of the base class of the user-defined implementation class. In our case it is `BON::Model`.
- Implementation class – This is the user-defined implementation class. In our case it is `CompoundImpl`.
- Wrapper class – This is the class which has to be generated to the specified implementation class. This will be the user-defined wrapper class. In our case it is `Compound`.

```
DECLARE_BONEXTENSION( BON::Model, CompoundImpl, Compound );
```

The `IMPLEMENT_BONEXTENSION` macro, inserted into a `.cpp` file, is for assigning the BON extension to a kind or a containment defined by the paradigm, or to a meta-kind defined by GME. The implementor may specify more than one kind, or even assign a concept to a kind and a containment at the same time. The parameters are the following:

- Wrapper class – The name of the BON extension which must be assigned. In our case it is `Compound`.
- Assignment string – This is a string literal containing a space separated list of kind names, containment rolenames or meta-kind names. In our case it is simply “Compound”.

```
IMPLEMENT_BONEXTENSION( Compound, "Compound" );
```

After this step the BON extension to the `Compound` concept defined by the paradigm is ready to use everywhere.

Note

It is not required that the name of the wrapper class is the same as the kindname. It is only good practice.

9.3.6.3. Assigning BON Extensions

As we mentioned above, not only *kinds* can be specified for a BON extension, but *containment* roles, even *metakinds* as well. It is possible that for one COM object more than one BON extension could be created. In order to avoid collisions and resolve them (if we can) there is a precedence defined among the names.

In the following enumeration the first is the highest precedence.

- Containment rolename defined by the paradigm (e.g. “CompoundPart”)
- Kindname defined by the paradigm (e.g. “Compound”)
- Metakindname defined by GME (e.g. “BON::Model”, “BON::FCO”, ...)

The rules are the following:

- If there is containment role assigned:
 - Only one containment role : create appropriate BON extension.
 - More than one containment role : throw an exception.
- If there is kind assigned:
 - Only one kind : create appropriate BON extension.
 - More than one kind : throw an exception.
- If there is metakind assigned:
 - Only one metakind and it complies with the implementation : create appropriate BON extension.
 - Otherwise : throw an exception.
- If there is no assignment:
 - Create the appropriate generic BON implementation.

A more sophisticated example is the following. The user creates an AtomEx BON extension with additional functionality extending the generic GME concept Atom. After that she extends the AtomEx with Parameter, and Parameter is extended with MainParameter which is assigned to a specific role.

```

DECLARE_BONEXTENSION(BON::Atom, AtomExImpl, AtomEx);
DECLARE_BONEXTENSION(AtomEx, ParameterImpl, Parameter);
DECLARE_BONEXTENSION(Parameter, MainParameterImpl, MainParameter);
...
IMPLEMENT_BONEXTENSION(AtomEx, "BON::Atom");
IMPLEMENT_BONEXTENSION(Parameter, "InputParameter OutputParameter Parameter");
IMPLEMENT_BONEXTENSION(MainParameter, "MainParameter");
    
```

9.3.6.4. Multiple Inheritance

It is a common for the implementor to want to use multiple inheritance in the context of BON extensions. A typical case is demonstrated in the next figure.

Figure 39. Multiple inheritance with BON extensions

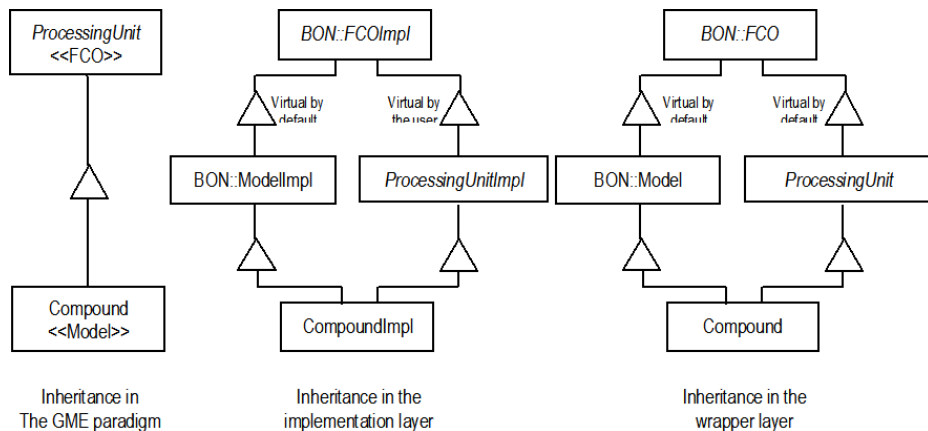

At first the user wants to implement a BON extension which corresponds to a ProcessingUnit concept. The metakind of ProcessingUnit is FCO, therefore the class in the implementation layer must be abstract and cannot be instantiated. Compound derives from ProcessingUnit in the particular domain, so the implementation class extends ProcessingUnitImpl. Because the metakind of Compound is Model, it has to derive from BON::ModelImpl also.

The rules that the user must comply with are the following:

- Abstract BON extensions – If a user wants to implement the common behaviour of classes in a base class, but she does not want to or she cannot assign any kind, containment to the extension, to create the appropriate wrapper class she must use the DECLARE_ABSTRACT_BONEXTENSION and IMPLEMENT_ABSTRACT_BONEXTENSION macros.
- Public inheritance – Only public inheritance may be used.
- Metakind compliance – In a BON inheritance chain, the user cannot mix the metakinds except of FCO (e.g. all descendants of a BON extension having Atom metakind will have Atom metakind)
- Virtual inheritances – In the case of diamond inheritance, virtual inheritance must be used (see how ProcessingUnitImpl extends BON::FCOImpl). In case of wrapper classes all inheritances are virtual.
- Multiple inheritance – In these cases DECLARE_BONEXTENSION2 or DECLARE_BONEXTENSION3 can be used.

The example code:

```
// Realization of the implementation classes
class ProcessingUnitImpl
  : virtual public BON::FCOImpl
{
  // Note: BON::FCOImpl is an abstract class by default
  .....
  void doSomething( ) { ... }
};

class CompoundImpl
  : public BON::ModelImpl, public ProcessingUnitImpl
{
  .....
};

// Declare BON extensions
DECLARE_ABSTRACT_BONEXTENSION( BON::FCO, ProcessingUnitImpl, ProcessingUnit);
DECLARE_BONEXTENSION2( BON::Model, ProcessingUnit, CompoundImpl, Compound);

// Implement BON wrappers (assignment if it is required)
IMPLEMENT_ABSTRACT_BONEXTENSION( ProcessingUnit );
IMPLEMENT_BONEXTENSION( Compound, "Compound" );

// Using the extensions
void print( const BON::FCO& fco )
{
  if ( BON::Model( fco ) ) AfxMessageBox( "It is a model!" );
  ProcessingUnit unit = fco;
  if ( unit ) {
    unit->doSomething();
    if ( Compound( unit ) )
      AfxMessageBox( "It is a Compound!" );
    else
      AfxMessageBox( "It is another descendant of ProcessingUnit!" );
  }
}
```

```
} // end of method
```

9.3.7. Essential Classes of BON2

As we noted discussing how to use MON classes, there are a lot of similarities between BON2 and MON regarding the usage and the architecture. This is because BON2 is based on MON. Examining the figure about BON2 classes that have the appropriate COM interface, we find that these classes are almost the same. For all BON2 classes, the user can find the proper operation with which she can obtain the meta information (e.g. the operation `BON::FCOImpl::getFCOMeta()` returns `MON::FCO`).

Figure 40. Relationship between the Project and BON Objects, associations to MON classes

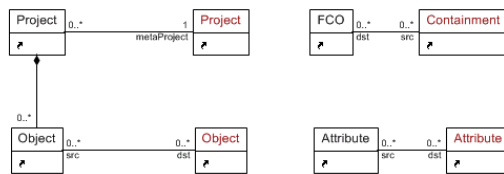

Looking at the next figure carefully, there are only two exceptional classes which do not have the correspondent COM interface (i.e. `ConnectionEnd` and `ReferencePort`). The concept of the `ReferencePort` may look familiar to someone who used the previous version of BON, but there are essential differences which will be discussed in the next subsection.

Figure 41. BON classes, which have the corresponding COM interface

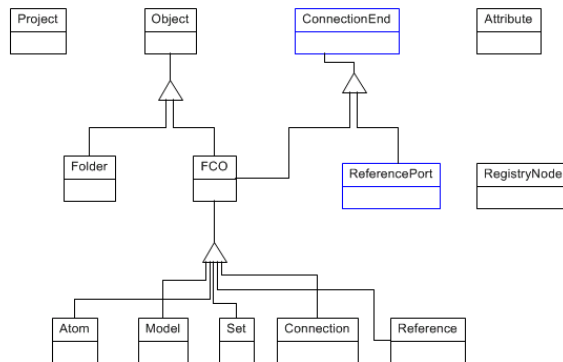

9.3.8. GME Metakinds in the Project

Objects in projects have metakinds according to the paradigm, and they can play only the roles and can take part in the relationships that come from the appropriate metakind. For example, if an object is a model (i.e. it is a `BON::Model` whose meta is `MON::Model`), the user may obtain the children contained by the object. The children are `BON::FCO` objects. The specific model kind (i.e. `MON::Model` objects) tells the user what the children's kinds can be (i.e. `Compound model` may contain `Primitive` or `Compound models` among others).

If somebody is familiar with GME, all the well-known GME concepts are familiar except of a new one called `ReferencePortContainer` with `ReferencePort` and `ConnectionEnd`.

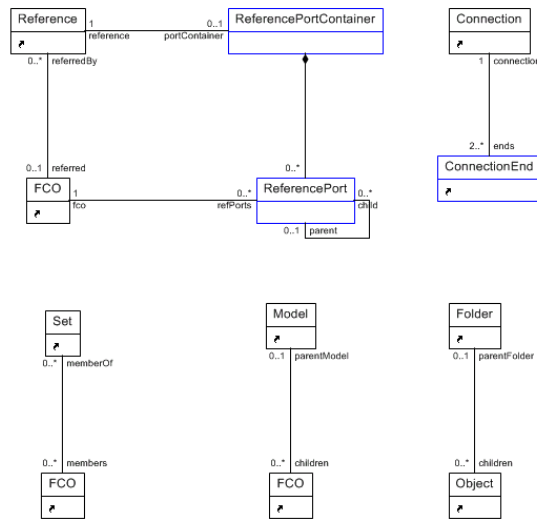
Figure 42. BON classes with their specific relationships

9.3.9. ConnectionEnds and ReferencePorts

Let's clarify with the previous and the next figure what ReferencePort means.

Note

During the explanation we assume that there is only one *Aspect* in the paradigm in order not to deal with relationships between objects, ports and aspects.

9.3.9.1. ReferencePort and Its Container

If a reference referred to a model, then this reference was called `BuilderModelReference` in the previous version of BON. Model references might contain reference ports. The port (i.e. the FCO) and the reference port were different objects.

In BON2 these concepts are retained, but they are clarified.

`BuilderModelReference` of BON is called `ReferencePortContainer` in BON2. GME allows that a reference may refer to models and other objects which are not models. It is obvious a reference may 'contain' reference ports if and only if it refers to a model. If the user changes the referred object from a model to an atom, then the reference cannot 'contain' reference ports. Because of these facts `ReferencePortContainer` is an interface (in contrast with `BuilderModelReference` object of BON) which is implemented by the reference when it refers to a model.

That means references can contain reference ports indirectly through the `ReferencePortContainer` interface which always has to be obtained from the reference before use (and which is not recommended to cache by the component implementor). Consequently, only `ReferencePortContainer` contains reference ports.

`BON::ReferencePort` is retained in BON2, but its primary ancestor is not the same as the ancestor of `BON::FCO`. The explanation is that primarily FCO is a metakind and reference port is another concept defined because of connections.

9.3.9.2. Relationship Between ReferencePorts

In the next figure we find a model called Model and four references (called Ref1, Ref2, Ref3 and Ref4) referring directly or indirectly to the model. Model contains two atoms called P1 and P2 which are ports.

Figure 43. Relationships of Model references and Reference-ports

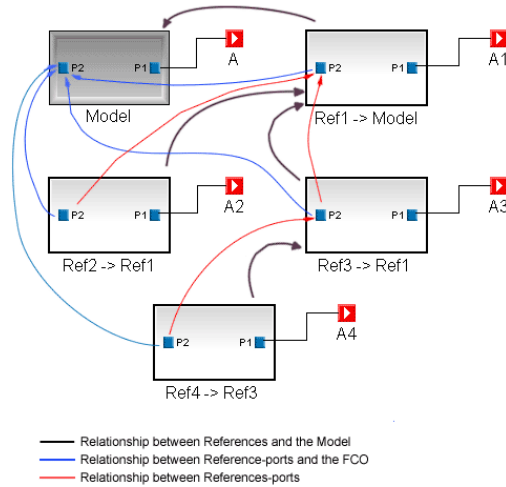

Because the references ‘refer’ to a model, they implement the `ReferencePortContainer` interface and they ‘contain’ reference ports with the same names (P1 and P2).

Reference ports refer to the port contained by the model (blue lines in the figure). We say that the reference ports are the descendants of the port. Ref2 refers to Model via Ref1. P2 of Ref1 is the parent of P2 of Ref2. The parent of P2 of Ref1 is null because Ref1 refers to Model directly. P2 of Ref1 has three descendant reference ports and two children (i.e. two immediate reference ports). This relationship might be important for the component implementor if she wants to handle the connections between objects in an advanced way.

9.3.9.3. ConnectionEnd and Connection

Connections in BON2 are implemented in a different way compared to the previous implementation. In both ends of a connection, only `ConnectionEnds` can exist. A `ConnectionEnd` can be an object itself – to be more precise, an `fco` – or a reference port. `ReferencePort` derives from `ConnectionEnd` because this concept is not placeable into the set of metakinds and it has a different meaning.

Let's see the following examples considering the previous figure to understand the described issues.

```
// the model called Model in the figure
BON::Model model;
// P2 of Model, we omit the acquiring operations
BON::Atom p2_model;
// Ref1 refers to Model
BON::Reference ref1 = model->getReferredBy();
// PortContainer of the model reference
BON::ReferencePortContainer rpc_ref1 = ref1->getRefPortContainer();
// Find the ReferencePort referring to P2
BON::ReferencePort p2_ref1 = rpc_ref1->getReferencePort( p2_model )
....
// Parent of this ReferencePort is null
p2_ref1->getParentPort();
```



```

// Descendants of P2 of Ref1 containing P2 of Ref2, Ref3 and Ref4
p2_ref1->getDescendantPorts();
// Children of P2 of Ref1 containing P2 of Ref2 and Ref3
p2_ref1->getChildPorts();
// Get referred FCO (i.e. p2_model, P2 of Model) of P2 of Ref1.
p2_ref1->getFCO();
....
// Get objects connected to P2 of Model directly or indirectly (via reference
// ports). It includes A, A1, A2, A3 and A4.
p2_model->getConnEnds( "", "", true );
// Get objects connected to P2 of Model directly without reference ports
// It includes only A.
p2_model->getConnEnds( "", "", false );
// Get objects connected to P2 of Ref1 directly or indirectly (via descendant
// reference ports). It includes A1, A2, A3 and A4. A is not included.
p2_ref1->getConnEnds( "", "", true );
// Get objects connected to P2 of Ref1 directly without descendant reference
// ports. It includes only A1.
p2_ref1->getConnEnds( "", "", false );

// Gets objects connected to P1 of Ref3 or its referencers that have the "src" role in
// the connection (A3, A4)
p1_ref3->GetConnEndsAs("src")
// Gets the objects connected to P1 of Ref3 that can be reached by outgoing
// meta_connection "src" role connections and have no such outgoing connections
// (A3, A4)
p1_ref3->getDirectConnEnds( meta_connection, "src" )
// p1_ref3 has no outgoing "dst" connections, so this returns p1_ref3
p1_ref3->getDirectConnEnds( meta_connection, "dst" )

```

It is good to know that the casting mechanism defined by the appropriate wrapper classes works transparently between `BON::ConnectionEnd`, `BON::FCO` and its descendants and `BON::ReferencePort` also. For example to decide whether a connection end is a reference port we can do this in two ways.

```

if ( BON::ReferencePort( connectionend ) ) { // do something }
if ( connectionend->isReferencePort() ) { // do something }

```

9.3.10. Type Inheritance in BON2

Type inheritance is special feature introduced in GME. This issue is implemented by interface called `BON::TypeInhObject`, `BON::Type` and `BON::Instance`. These are interfaces and an FCO always implements one of `BON::Type` or `BON::Instance`.

In order to obtain the type inheritance interface the user has to use the `getTypeInhObject()` of `BON::FCO`. After a simple cast the user may obtain the type of the instance or the subtypes of the type.

After obtaining the type inheritance interfaces, the user implicitly holds a reference to the fco itself.

Figure 44. Relationships of Attributes, Type-Inheritance Objects and RegistryNodes

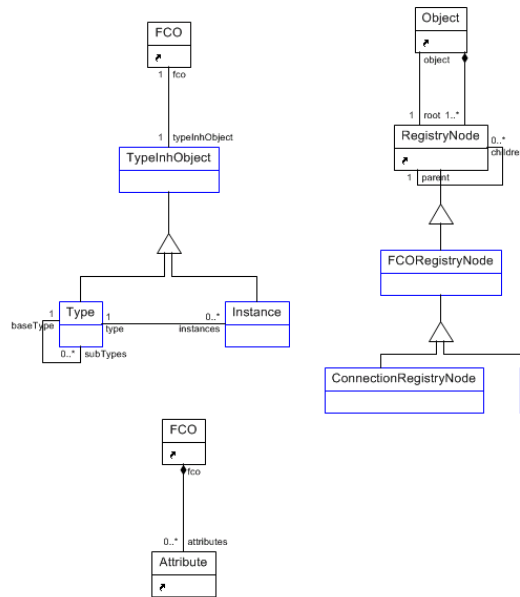

9.3.11. Registry, Attributes and Object Preferences

The registry of a BON2 object is implemented similarly to the registry of MON. The root `RegistryNode` can be accessed with the `getRegistry()` of `BON::Object`. The root registry node is defined in order to separate the interfaces; the real and existing root nodes are children of the dummy root node.

When using the registry, it is important to know that caching registry nodes is not recommended:

- If the user uses at least one registry node (even the dummy root), she holds a reference to the appropriate object implicitly. Before the object could be disposed, all nodes must be released. This is true for `BON::Attribute` also.
- If the component not only reads the project but may modifies the registry of an object or if the component is an add-on reacting to events, then when modifying or erasing at least one registry node, all registry nodes of the object will be invalid and the user has to obtain them again.

As we know, objects in the project has predefined properties defined by GME. Mainly these properties are related to visualization and implemented in the registry of the object. The appropriate access (including the type – integer, string, long, etc. - and the registry path) of these values varies. Using them manually via the generic registry interface is very error-prone and difficult to memorize.

This is the reason why special root registry nodes are introduced that extend the `RegistryNode` interface. These are the following: `FCORegistryNode`, `FCOExRegistryNode`, `ConnectionRegistryNode` and `ModelRegistryNode`. Except for `FCOExRegistryNode`, which can be obtained from `fcos` which are not connections, the use of the others is obvious.

An example:

```
// Get the color of the portnames of the port
COLORREF crPort = BON::ModelRegistryNode( model->getRegistry() )->getPortNameColor();
...
```

```
// Obtaining the position of an FCO in the Aspect 'Aspect'  
BON::Point pt = BON::FCOExRegistryNode( fco->getRegistry() )->getLocation( "Aspect" );
```

9.4. How to create a new component project

The first time you wish to create a component project, you must run `C:\Program Files\GME\SDK\BON\Wizard\setup90.js`. This registers the GME project types in Visual Studio.

To create a BON project, open Visual Studio. Go to **File | New Project**. Under **Visual C++**, select **GME**, then the type of component you wish to create. Give the project a name, then hit **OK**. Hit **Next >**. Under **Paradigms**, enter the name of the metamodel. Hit **Finish**.

The resulting configuration is a ready-to-compile Visual Studio workspace (`Component.dsw`, `BonComponent.dsw` or `BON2Component.dsw`). If the BON is selected, simple `Component.cpp` and `Component.h` files are generated, in case of BON2 these files are `BON2Component.h` and `BON2Component.cpp`. The user is expected to implement the component by modifying these two files and adding other files if necessary. The other files in the workspace are normally not modified by the user, and for this reason they are generated with a read-only attribute.

After building the project, the `component.dll` is registered and associated with the paradigms you specify. When you edit a model using one of these paradigms and press the interpret button, you launch this component (if there are more than one components associated with the given paradigm, a menu will pop up to choose from). The `.dll` will be located and loaded at this time.

9.5. Extending the Component Interface using the BON Extender interpreter

After writing a few interpreters, one realizes that the extension of the Component Interface (as shown above) is a repetitive and boring task. The BON Extender interpreter is aimed to automate this process. Based on a specific metamodel, domain-specific skeleton code is generated. Thus when you write your interpreter (in the specific paradigm), you will have only to enrich the generated classes with the functionality you want.

The BON Extender interpreter creates specialized class definitions for all object kinds (even for abstract ones). These specialized classes will be instantiated when your interpreter executes. The output consists of the skeleton class definitions and their implementation, in two files. The filenames are formed based on the paradigm name, appended with the string "BonExtension". A skeleton visitor class and a log file is generated, also in the same directory, which has the name of the paradigm appended by the "Visitor" and "BonExt.log" strings respectively.

We will discuss in detail the content of the class extensions header file.

9.5.1. Naming convention used

Plain names are used for FCOs and Folders, Attributes. These names are usually valid identifiers for C++ compilers. However in the case of EnumAttributes, the enumerated items will be encapsulated by a C++ enumeration type. These fields may be defined without many restrictions during meta-modeling, so a name validation takes place, converting non-alphanumeric characters to underscores. If the enumeration value starts with a digit a leading underscore will be inserted.

In order to avoid name conflicts (e.g. in case default name is used: a Connection kind may be named Connection) the specialized classes will be part of a namespace generated based on the validated paradigm name.

Below are some examples generated based on the SF paradigm. Processing and Compound are model kinds in this paradigm.

```
namespace SF_BON {
DECLARE_ABSTRACT_BONEXTENSION( Model, ProcessingImpl, Processing);
DECLARE_BONEXTENSION( Processing, CompoundImpl, Compound);
class ProcessingImpl : public ModelImpl {
public:
    std::set<InputSignals> getInputSignals();
    std::set<OutputSignals> getOutputSignals();
    std::set<Signals> gets();
};
class CompoundImpl : public ProcessingImpl
{
public:
    // kind and role getters
    std::set<Processing> getParts();
};
}; // end namespace
```

Processing (with Model stereotype) has no ancestors in the metamodel, so it derives from the BON::ModelImpl class. Compound derives from Processing so this will be reflected in the generated skeleton.

Container kinds, like Models, Sets and Folders, will have specialized get methods returning the contained roles (in case of models) and kinds (in case of sets, folders).

The Compound class' getParts() method returns a set of Processing instances, so users don't have to deal with the conversion from BON::Model to SF_BON::Processing type. The method name is based on the role name "Parts" (see containment relation between Compound and Processing).

The Processing class has three get methods which are related: two get methods (getInputSignals, getOutputSignals) which return the contained objects having InputSignals and OutputSignals role, and an aggregated get method (gets) which returns all objects derived from the Signal base. The suffix "s" comes from the role name specified in the SF metamodel for the containment between Processing and Signal. If this rolename had been empty then the getSignal name would have been used. Sometimes name conflicts happen because of these naming conventions, therefore the following distinction is made by the BonExtender: the aggregated get methods may get an int dummy parameter.

If the Signal atom had been non-abstract and the rolename empty in the meta-model the following get methods would have been generated:

```
class ProcessingImpl : public ModelImpl {
public:
    std::set<InputSignals> getInputSignals();
    std::set<OutputSignals> getOutputSignals();
    std::set<Signals> getSignals(); // role getter
    std::set<Signals> getSignals(int dummy); // aggregated
};
```

Connections will have specialized source and destination get methods. However, when a connection can have a reference port as its end, the return value will be simply BON::ConnectionEnd. In the case below no reference ports are involved, so a specialized class like Signal will be returned by the get methods:

```
class DataflowConnImpl : public ConnectionImpl
{
public:
    // connectionEnd getters
    Signal getSrc();
    Signal getDst();
    //BUP
```

```
// add your own members here
///  
};
```

Beside this, the source and destination kinds will have two additional get methods: one for inquiring the connection links (starting or ending at that particular kind), another for inquiring the kinds connected to the object through a particular connection.

```
class SignalImpl : public AtomImpl
{
public:
    // connection end getters
    std::multiset<Signal> getDataflowConnSrcs();
    std::multiset<Signal> getDataflowConnDsts();
    // connection link getters
    std::set<DataflowConn> getDataflowConnLinks();
    std::set<DataflowConn> getInDataflowConnLinks();
    std::set<DataflowConn> getOutDataflowConnLinks();
    ///  
    bool isMyParentPrimitive();
    std::string className() { return "Signal"; }
    ///  
};
```

Furthermore, all FCOs which have attributes will have special get methods generated, with corresponding return types to their specification (in case of `EnumAttribute` an enumeration type definition will be generated based on the items declared in the “Menu items” field).

9.5.2. Ordering

The classes are generated into the header file based on the following principles: groups are formed for classes which have a inheritance relationship among them. The groups are ordered based on how many model kinds they contain, in descending order. Such a group is dumped in top-down order (based on inheritance). The methods inside a class are categorized as attribute, connection get methods and role get methods (for models) set-member get methods for (set).

The “///
” and “///
” (standing for “begin user part”, “end user part”) comments are intended to provide a space where the user may add her own methods and members. If the user decides to regenerate the skeleton (i.e. the paradigm changes), she won't have to insert once again her own method and member definitions into the skeleton class definitions. The BON Extender interpreter will parse for these special comments inside class definitions and it will insert the user defined part into the new generated header file. This header file contains two global BUP/EUP pairs, which are intended to give a place for the user's class definitions, if any. These global comments have to start on the first character of the line. The BUP/EUP comments inside a class are not limited such way. These special comments are inserted only in the generated header file.

9.5.3. Limited extension

It can happen that the user doesn't intend to work with all classes generated for a paradigm (i.e. the hardware definition part may be insignificant for implementer, since her interpreter is concentrating on the dataflow part). The “**Select classes to extend**” dialog that appears during generation is intended for such cases. It lists all the classes, which will be generated by default. If an object kind is selected for extension then its ancestors are selected too, and if it is deselected then its descendants are deselected too. If you want to limit the set of generated classes, then it is recommended to select “no” for each root object (staying on top of the inheritance hierarchy) in the domains you don't want to deal with.

There is another way of using this feature: if you would like to extend the classes only to some extent (not all classes down the inheritance hierarchy), you may like to handle some derived classes together (i.e.

you want to handle `InputSignals` and `OutputSignals` together as `Signal`). In such cases you can select the base class (`Signal`) and deselect the derived classes (`InputSignal`, `OutputSignal`). When your interpreter executes, a base class instance will be generated for each derived object in the model. This has consequences for the generated *get* methods of containers (models, sets, folders): if a container is extended (`Processing`) and some of its contained objects are not (`InputSignal`) then the specific getter (`getInputSignals`), which is intended to give back a set of the specific kinds contained will return with these objects cast to the nearest extended ancestor (`Signals`). There is a similar mechanism for connections, too.

```
class ProcessingImpl : public BON::ModelImpl
{
public:
    std::set<Signal> getInputSignals();
};
```

Since FCO (as a stereotype) objects are extended too, and may not be instantiated (at modeling time no abstract FCO object is visible) some limitations exist, which are enforced by the dialog. If an object which inherits directly from an FCO is deselected, then not only the objects below it, but the whole inheritance tree is deselected.

If an FCO object is selected then not only its ancestors, but all of its FCO descendants and their immediate non-fco children are selected too. In other words the extension selection/deselection is limited to non-fco sections of the inheritance trees.

If the user would like to extend some of the classes from the hierarchy below, then `ModelBase`, `AtomBase` and `SetBase` classes are definitely needed. Their descendants may be selected or deselected at the user's choice.

Figure 45. Example metamodel for the BONExtender interpreter

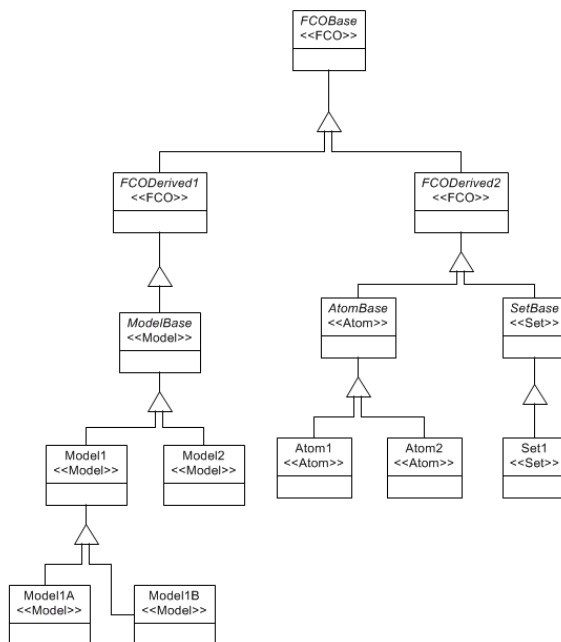

10. Constraint Manager

10.1. Features of the new Constraint Manager

GME contains the improved constraint manager which is fully compliant with the standard OCL 1.4 specification. Here we enumerate the features of the Constraint Manager, without delving.

10.1.1. Standard OCL features

The following features are new regarding the language (MCL), which was used earlier to write constraints in GME.

- The language is a typed language.
- `Undefined` is introduced as a value.
- Variable declaration is supported. Performance and readability can be taken into consideration.
- All OCL operators are implemented.
- Operators have the right precedence and associativity.
- All features of predefined primitive types are implemented.
- Types can be referred as `ocl::Type`, and not as `ocl::String`.
- Namespaces can be used.
- Typecast is implemented.
- All compound types of OCL are implemented.
- Almost all predefined iterators (exception is `sortedBy`), as well as the generic `iterate` are supported.
- Implicit variables are implemented.
- More sophisticated features and expression resolution are supported.
- Short-circuit operators and iterators are supported.
- Features defined by MCL are improved. More security is provided, but these calls remain insecure.
- The meta-kind features are linked to the appropriate meta-kinds.
- Predefined OCL types are extended with some useful features.
- Standard access of attributes is supported.

10.1.1.1. New and Improved features in GME

The following features are new considering the functionality of the former version of Constraint Manager.

- All former features and functionality are still available, although they are either deprecated or improved.
- New kind (`gme::Project`) is introduced. New predefined variable called `project` is available in expressions.
- The Constraint Function is made to be compliant with Constraint

- Definitions defined by OCL 2.0.
- More sophisticated error detection at syntax and semantic checking.
- More detailed report about constraint violations.
- User-friendly dialogs reporting errors and violations.
- The state of the evaluation process is visible; however, it cannot be interrupted yet.
- The Constraint Browser displays all constraints even if a constraint has errors.
- The model is maintained in a clean state (deleted user-constraints and enabling information are always eliminated)
- The interface of constraint-enabling functionality fits the concept of kinds, types, subtypes and instances. (i.e. type inheritance)

10.1.2. Limitations and Special Issues

Due to some special properties of the GME Meta-Modeling environment, certain extensions and limitations exist. These are discussed below.

10.1.2.1. Inheritance at Meta-Modeling Time

GME specifies three kinds of inheritance (standard, implementation and interface inheritance). But none of these are part of GME Meta (i.e. meta-information generated by Meta-Interpreter). Inheritance is defined only to help the meta-modeler and to facilitate her work. Consequently, inheritances only act as operators at meta- modeling time.

This situation requires us to ease some strict rules of standard OCL. These rules include the following:

- Some well-defined abstractions, which were made by the modeler, disappear because all information is lost. For example, if in future the standard OCL rules about accessing an association-end are allowed, then it is likely that many association-ends cannot be used due to ambiguity.
- For a kind, which is defined in the paradigm, if either its kind is `gme::FCO` or its `Is Abstract?` flag is set, then it cannot be referred in OCL expressions because these types will not appear in the interpreted meta.
- Inheritance information cannot be acquired between two kinds defined by the paradigm, because this knowledge is lost during the interpretation.
- Although standard OCL says that meta-kind information cannot be obtained in expressions, referring to meta-kinds is allowed. For the time being, this is the only way to get some common information about kinds.
- If a constraint is associated with a kind, then the kind and all of its descendants will get a constraint object which is the same as the defined one, but is a distinct entity. This problem grows in size along with the sizes of the XMP and XML files.
- If the modeler would like to write a Constraint Definition and attach it to the kind, then the definition will be associated only with that kind, and not with its descendants. This is because there is no such a mechanism mentioned in the previous point. Therefore, if the modeler wants to have a definition attached to more than one kind, she must define a meta-kind as the context of the definition. Though the propagating mechanism can be implemented, the usage of Constraint Definitions would be clumsy; the user always would have to cast because of the lost inheritance information.

10.1.2.2. Retained Meta-Kind Features

For the time being, all features – particularly methods – that are defined by the former language of GME constraints called MCL are retained in this implementation, with some improvements.

The reason for this decision was that the semantic checking of OCL expressions always requires a well-formed and valid paradigm (naturally, during the time of meta-modeling, the paradigm is neither well-formed, nor valid). During meta-modeling, the task of gathering all the information that the checking would require either writing a new component that always serves the valid and well-formed part of the paradigm or integrating the Expression Checker and Meta-Interpreter. In the latter case, only syntax checking would be performed at meta-modeling time, and the semantic checking only could be done after the interpretation.

In case a solution exists, all features (except for some: e.g. `gme::Object::name`, `gme::Object::isNull()`) will be obsolete as well, because this sort of information will be obtained by accessing kinds and meta-kinds (as predefined types of the new version of OCL implementation) or else the features will be mapped to standard OCL features (e.g. `gme::FCO::connectedFCOs` to association-ends).

Another important issue is that these features are not secure; however, their implementation and signature are improved and modified. For example, `connectedFCOs` of `gme::FCO` expected two arguments in the former version of the GME constraint language: the name of the role and the name of the connection. The result can be an empty `ocl::Set` even if the specific object does not have any connection or any role specified in the arguments. These kinds of methods should be mapped to secure feature calls, i.e. association-ends.

The modifications of these methods are as follows:

- The features are reorganized and are associated with specific and most appropriate meta-kinds. For example, method `refersto()` can be called on objects whose meta-kind is `gme::Reference`. This was required because MCL is not a typed language, in contrast to OCL.
- Wherever a method expected the name of a kind as an argument typed as `ocl::String`, the feature now expects the kind typed as `ocl::Type` (i.e. identifier) according to the new signature. With this slight modification mis-spelled names can be filtered immediately after writing the expression and the expression is more readable. On the other hand, features can be overloaded as ambiguity is avoided. For example, `gme::Model::parts(role : ocl::String)` vs `gme::Model::parts(kind : ocl::Type)`.
- If a method expects the name of a kind, the kind of the kind (i.e. the meta-kind) is specified, too. The implementation of the method checks whether the name is the name of a kind defined in the paradigm, and whether the kind conforms to the expected meta-kind. If these conditions are not satisfied, the proper exception is thrown and `undefined` is returned.
- The implementation of all features, before performing, checks whether the object is `null`. If it is `null`, exception is thrown, and `undefined` is returned.

The benefits of these features are:

- The cautious modeler has free rein in writing expressions, because the features are not fully checked.
- A constraint can already be attached to different kinds without dealing with difference and conformance, because the features are defined by meta-kinds.

We strongly recommend that the special feature `gme::FCO::attribute` should not be used. In MCL, this method returns objects with different types depending on the type of the attribute. This feature is also not very secure; in the expression `oclAsType`, it returns `ocl::Any` in this implementation. It is better to somehow cast the kind itself, and use the standard access of attributes defined by OCL.

10.1.2.3. Special Features of Predefined OCL Types

In GME, there are some special features with which predefined OCL types are extended, but they are not part of OCL specification.

These are in order:

- `ocl::String::intValue()` – This feature exists because of backward compatibility, thus it is deprecated. Standard `ocl::String::toInteger()` must be used instead.
- `ocl::String::doubleValue()` – This feature exists because of backward compatibility, thus it is deprecated. Standard `ocl::String::toReal()` must be used instead.
- `ocl::String::match(ocl::String)` – This method is introduced so that regular expression can be used to test whether a string matches a specific format. This feature can be used well for example to test whether the value of a string attribute has a special format or not.
- `ocl::Collection::theOnly()` – This method exists because of backward compatibility, but it is not deprecated. It returns the sole element of a compound object. If the collection either contains more than one element or is empty, `undefined` is returned.

10.1.2.4. Multiplicity

In the interpreted meta-model, the multiplicity of containments, membership of sets, and association-ends is omitted and lost. The cardinality is forced by constraints generated by the Meta-Interpreter.

The consequence is that all features that have multiplicity (i.e. the features mentioned above) return `ocl::Set`. In GME, there is a method `ocl::Collection::theOnly()` with which this problem can be solved.

10.1.2.5. Enable-Disable Constraints

This is a special feature of GME with which the user may disable constraints defined in the paradigm.

This disabling has a limitation: constraints, which have priority one and are defined in the meta-model or included libraries, cannot be disabled

The user interface allows the user to change this flag by kind, type and subtype, as well as by instances. This flag can be set for objects directly or implicitly (i.e. the value of the flag is inherited), taking advantage of type inheritance.

10.1.2.6. Constraints at Modeling Time and In Libraries

In GME, a special inheritance called type inheritance is introduced at modeling time. To learn about more this feature, see chapter Type Inheritance.

This solution raises a question about how to specify constraints whose context is a type, a subtype or a sole instance. The answer is the user-defined constraint, which does not differ from the constraint defined at meta-modeling time (meta-defined constraint) except that the user-defined constraints are stored in the registry of the model, rather than in the paradigm.

Although the context of user-defined constraints can only be a kind, with constraint disabling this context can be tightened into specific types or even instances.

As an expert GME user knows, libraries can be defined and attached to a designated folder – i.e. to the `RootFolder`. A library will be a read-only part of the model; therefore, all user-defined constraints are fixed and cannot be changed. This allows the user to create libraries that force additional well-formedness or validity as well.

10.1.3. Types and Constraints (Expressions)

In GME all types of available constraints (equation of a constraint or a constraint definition) contain another predefined variable called `project`, in addition to `self`. Through `project`, the user can obtain all instances of a kind and attach constraint definitions to them. The instances should be associated with the paradigm itself, rather than with the particular kind of the paradigm.

10.1.3.1. Type Resolution

In GME, namespaces are used to refer to kinds, meta-kinds, predefined OCL types, and predefined GME kinds unambiguously. If the user does not use namespace, than the type resolution is well-defined.

The order of resolution:

- Look for a kind defined in the paradigm.
- Look for a meta-kind defined by MetaGME.
- Look for a predefined OCL type.

Note

For example, be careful when using `ocl::Set` without namespace, because it is first resolved in a meta-kind, `gme::Set`.

The following is a list of pre-existing namespaces:

- Predefined OCL types are in the `ocl` namespace.
- Predefined meta-kinds of GME are in the `gme` namespace.
- Kinds defined in the paradigm can be referred to unambiguously using the namespace `meta`.

10.1.3.2. Invariants

In GME, only invariant constraints can be written, although a GME constraint has further properties with which the invariant closes to post-condition constraints.

In standard OCL an invariant constraint is defined if both the type of the context and the equation of the constraint are specified. However, a constraint is defined completely if the user names the invariants and sets the additional properties' values.

Event: (special interpretation of messages of OCL 2.0)

A constraint by default can be evaluated on demand. If the user associates events for a constraint, it will be evaluated as well, when the context's object receives such kind of events.

With these properties (if at least one is set) an invariant constraint can be considered as a post-condition. If the constraint has no events associated, then the constraint is evaluated on demand only.

The events are the following:

- On close model – The user closes the model. (Model)
- On create – The user creates an object. (Object)
- On delete – The user deletes an object. (Object)

- On new child – The user creates an object in a model or folder. (Model, Folder)
- On lost child – The user removes an object in a model or folder. (Model, Folder)
- On move – The user moves an object. (Object)
- On derive – The user creates a subtype or an instance of a type (Model)
- On connect – The user connects the fco to another. (FCO)
- On disconnect – The user disconnects the fco to another. (FCO)
- On change registry – The user modifies the object's registry. (Object) (Not implemented)
- On change attribute – The user changes the value of an attribute of the fco. (FCO)
- On change property – The user changes the value of a property of the object. (Object)
- On change association – The user changes the association of the connection. (Connection)
- On refer – The user refers to the fco with a reference. (FCO)
- On unrefer – The user removes a reference that points to the fco. (FCO)
- On include in set – The user includes the fco into a set. (FCO)
- On exclude from set – The user excludes the fco from a set. (FCO)

Priority: (evaluation order of constraints)

The higher priority an invariant has, the earlier it will be evaluated.

The highest priority, 1, has special meaning. When an object violates an invariant with priority 1, a critical violation occurs. If a constraint was performed by an event, the changes will be aborted. This prevents a model (instance of the paradigm) from having an inconsistent state. For lower priorities the user decides whether, the modification may be committed or aborted.

The default value is 2.

Depth: (extension of the invariant's context)

When a modification is made and it generates an event, a constraint may be evaluated even if the constraint is not attached to the kind whose instance generated the event. This condition depends on the value of the Depth attribute. This attribute applies only to Models only.

- 0 – the constraint will be evaluated if and only if the context's object receives events specified by the events attributes.

- 1 – the constraint will be evaluated if the context's object and/or its immediate children receive events specified by the events attributes. This is the default value.
- any – the constraint will be evaluated if the context's object and/or any of its descendants receive events specified by the events attributes.

10.1.3.3. Constraint Definitions

In the former version of the Constraint Manager only Constraint Functions could be defined. They were similar to Constraint Method Definitions, with the limitation that they only could return `ocl::Boolean`.

In this implementation, the Constraint Function is updated to be compliant with the Constraint Definitions specified by OCL 2.0.

The set of the attributes of the former Constraint Function is extended.

The attributes include the following:

- Stereotype – Stereotype of the definition, it can be either method or attribute.
- Return type – The returned kind or meta-kind of the definition.
- Context – The context of the definition. It can be either a kind or a meta-kind.
- Parameter list – The parameters of the method definition, separated by a comma.
- Equation – The expression of the definition.

The definition of Constraint Definitions requires that the context, the return type and the expression must always be defined.

Due to this extension, the Meta-Interpreter of GME had to be slightly altered in order to better interpret the extended Constraint Functions. Of course, XML files exported before this modification and XMP files interpreted by the former Meta-Interpreter can still be imported and used.

These Constraint Functions will be recognized as Method Definitions with the context of the singleton `gme::Project` and with `ocl::Boolean` as the return type. Errors may occur, however, because these methods cannot be called in expressions as a function, rather as a method of the predefined variable called `project`. Therefore, only these slight modifications must be made manually.

10.2. Using Constraints in GME

As an expert metamodeler knows, in the paradigms there are rules that cannot be expressed only with class diagrams. These constraints used to be written in informal language, (i.e. annotations), and the modeler interpreted it freely, even she might have misunderstood the semantics and/or the syntax.

In GME we support a constraint language, which is compliant with OCL 1.4. Because of this, more sophisticated rules can be written and built into the paradigms.

10.2.1. Constraints defined by the Paradigm

Constraints can be associated only to kinds. In order to do this, we have to switch to the Constraints aspect in the Metamodeling Environment of GME and we may drag & drop a new Constraint to the Model Editor.

Constraints can be connected to any kind in the paradigm. In this case the context of the constraint will be the appropriate kind, otherwise (i.e. the constraint is stand- alone), its context will be the singleton instance of `gme::RootFolder`. Constraints can be connected to more than one kind if it expresses common rules for them.

If a constraint is associated with a base-kind, then all descendants will have that constraint, as well.

After defining the context, the user has to *Name* the constraint. The names must be unique within kinds. Thus a kind cannot have constraints inherited from the base- kind and associated directly with the same name.

Note

It is not required that the name include the text: constraint or any form of it.

If the constraint is violated, then the content of the *Description* will be shown, thus, this field must be very descriptive so that the user can fix the problem.

The expression (i.e. the equation) of the constraint will be evaluated on all objects of a kind, and it must return `true` or `false` (in case of an exception, it returns `undefined`). The context can be accessed through the self variable (As we mentioned earlier, the GME project itself is also available as `project`.)

After the properties of the constraint are filled in, the user may enable the event- based evaluation. If it is required, she may set the constraint to critical setting *Priority* value to 1. In this case, the constraint will be evaluated when an appropriate event is sent, and the modeler can only abort the last operation if the constraint is not satisfied.

Figure 46. Constraint associated to the Compound kind in the SF paradigm.

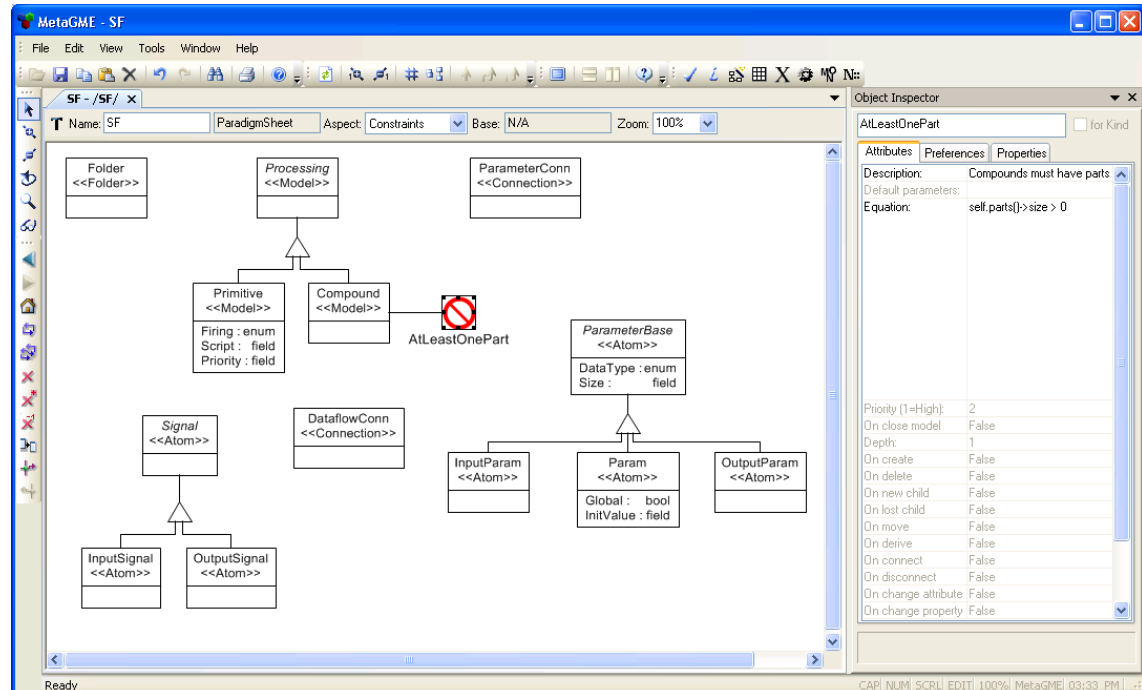

10.2.2. Constraint Definitions (Functions)

In GME the former Constraint Function is improved to comply with Constraint Definitions introduced by OCL 2.0.

The two attributes of a Constraint Function called *Parameter list* and *Definition* are retained and have the same syntax and functionality.

The expression of the Definition can already return any type not only `ocl::Boolean`, but it must be the same or a descendant of the type specified in the *Return type* attribute. This attribute can hold only simple and not compound types. For example: `ocl::Set(gme::FCO)` cannot be written; only `ocl::Set` is valid.

In order to facilitate the call of a Definition, which does not have any parameters, the Definition's *Stereotype* can be set to *attribute*.

For the time being the *Context* is an attribute rather than an association, so it must be supplied explicitly. The intention is that the user will be able to write more generic Constraint Definitions supplying a GME meta-kind as the Context of the Definition. With this solution the difficulties caused by the inheritance information loss is easily solved, because the constraint writer can use the commonalities of different kinds without casting objects' type explicitly to the appropriate kinds.

It is good practice to specify the context as a meta-kind or `gme::Project` if a Constraint Definition must or can be associated with more than one kind.

The context of the Definition can be accessed as `self`. If the *Context* is `gme::Project` then `self` and `project` point to the same object (i.e. singleton project object)

Constraint Definitions can be called from other Definitions or Constraints, even being recursive.

Figure 47. deRef constraint definition in the paradigm MetaGME deRef

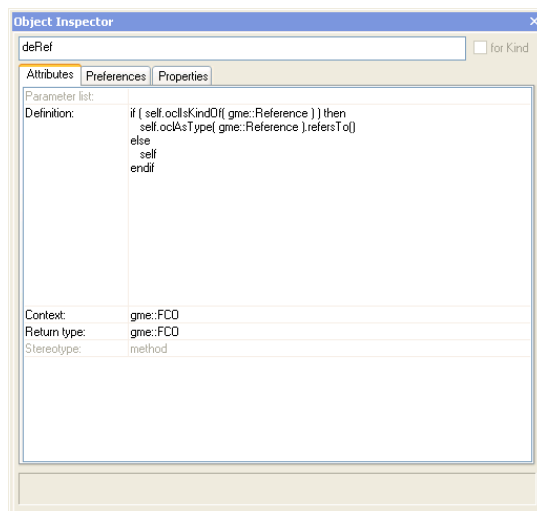
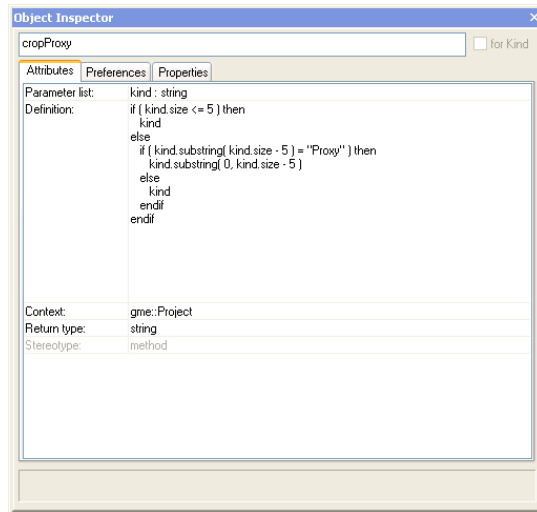

Figure 48. cropProxy constraint definition in the paradigm MetaGME cropProxy

10.2.3. Syntax and semantic errors

User defined constraints and constraint definitions may have syntax and semantic errors. Misspelled keywords, unclosed brackets, missing or superfluous elements in OCL expression lead to syntax errors. Semantic errors can be invalid or non-existent feature calls, variable redefinitions, wrong or invalid parameter list, or non-conformant types and so on.

These errors are displayed immediately after the user modifies and leaves one field of the Constraint or Definition. If it is fully defined the **Syntax and Semantic Error Dialog** is shown.

Because one constraint can be connected to more than one kind, the dialog enumerates all constraint and kind pairs. In the list violations can be sorted by Constraint's type, context or name.

Selecting an association, the text of the Constraint is shown on the left of the dialog with all primary errors (i.e. errors that do not come from other). Choosing an error, the line is selected in the expression window where the error is detected.

If a constraint is parsed successfully, then a semantic check is performed. That is the reason why syntax errors are displayed first (yellow icons). If there are no syntax errors, then semantic errors are shown (red icons).

Figure 49. Semantic errors in a Constraint Definition called WrongConstraint WrongConstraint

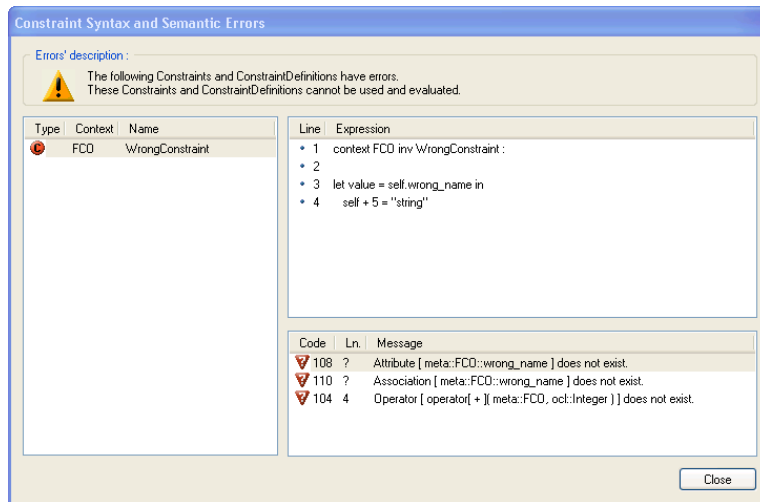

After interpreting a paradigm when a user tries to use the interpreted meta-model (create or open a model) all constraints and definitions are examined. If errors exist, the appropriate constraints (definitions) will be disabled and cannot be used. Constraints depending on a failed Definition are not available as well.

10.2.4. Evaluating the constraints

During modeling time the well-formed and valid constraints are used to maintain the model's consistency.

Constraints can be evaluated in several ways. These are the following:

1. Event-based constraints are evaluated if the appropriate event (i.e. the event that triggers the constraint) is performed on the objects. These constraints may be evaluated even if they are not associated with the object, which received the event (see `Depth` attribute of `Invariant`).
2. All existing constraints defined by either a library, the model or the paradigm can be evaluated on demand executing the **Tools | Check Constraints | Check All** command.
3. All constraints associated to the active and opened Model or associated to its immediate and indirect children can be evaluated on demand executing the **Tools | Check Constraints | Check** command. Examining the children may be excluded at the **Constraint Browser** dialog's **Settings** page.
4. A specific constraint can be evaluated for all objects to which it applies at the **Constraint Browser** dialog's **Constraints** page.
5. For a specific object, all constraints can be evaluated at the **Constraint Browser** dialog's **Kinds and Types** page or executing the **Constraint | Check** command of the context menu of the **Model Browser**.

Note

Before interpreting a model it is highly recommended that the user execute the **Check All** command because it is likely that the paradigm or a library contains pure on-demand constraints which are evaluated only if the user would like to.

10.2.5. Altering the evaluation process

In GME the user may change some settings to alter the evaluation process. This can be done by opening the **Constraint Manager**'s main dialog (**Tools | Display Constraints**) and by clicking on the **Settings** page.

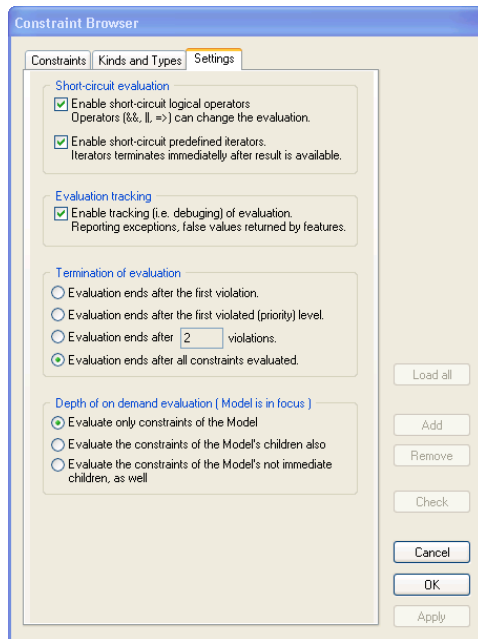
Figure 50. Settings of the constraint evaluation

10.2.5.1. Short-circuit evaluation

As OCL is a predicate and query language, during the “execution” of the constraints nothing is altered in the underlying model. In some cases – for example the model is quite huge and the evaluation would be time-consuming – logical operators and iterators may be switched to short-circuit mode: if the result is already available and the further operation will not modify the model, these features can return earlier. With these options, the performance may be improved.

10.2.5.2. Evaluation Tracking

If this option is off, constraints’ evaluation is not debugged, and only the context and the result (false or undefined) are shown in the **Constraint Violations** dialog.

This option may be turned on, if the user would like to test the paradigm (i.e. constraints)

10.2.5.3. Termination of evaluation

With these options the user can manage when the evaluation process must terminate.

If there were a lot of constraints and the model was too large, the **Check All** command would take too much time. In this case the user can shorten the evaluation to concentrate on the first violations.

10.2.5.4. Depth of on-demand evaluation

If the user wants to evaluate all constraints on the currently selected model, she may choose which constraints have to be checked. The default is that the constraints of the model and its immediate children are executed.

10.2.6. Run-time exceptions and constraint violations

If constraints are evaluated they can result in `true`, `false` or `undefined` depending on whether the constraint is satisfied or not, or during the execution some exceptions were thrown.

In the two latter cases, a **Violation Dialog** pops up displaying the violations and/or exceptions. The dialog has two views; in the compact view only one violation is shown in contrast to the detailed view in which all violations are enumerated at the left of the dialog. The user may switch between the views with the **Expand/Collapse** button.

Both of the views have the close buttons at the bottom-left corner of the dialog.

- **Close** button is used to close the dialog simply. If the violation dialog appeared because of an event, this button means that the user approves the violating modifications at that time.
- **Abort** is enabled only if at least one event-based and critical (*Priority* = 1) constraint is not satisfied. In these cases **Close** button is disabled to force the user so that she aborts the modification.

Note

If the paradigm is in the testing phase it is recommended that none of the constraints are critical in order to examine constraints simply.

10.2.6.1. Compact view

In the compact view the most important properties are shown of the current violation.

These are the following:

- Full name – The concatenation of the context name (with namespace) and the constraint name.
- Description – Description of the violation (i.e. the meaning of the constraint)
- Variables – Variables that are defined in the constraint (it always contains the self and the project variables)

If there are more violations at the same time, then the user can iterate over those violations using the **Previous** and **Next** buttons.

10.2.6.2. Detailed View

In addition to that compact view, the detailed one displays all the information can be gathered during the evaluation.

Here we can see all violations at the left of the dialog. The user can sort the content similarly to the **Syntax and Semantic Errors** displaying dialog. The content of the whole dialog is changing according to the selected item in the list.

At the right we can track and follow the constraint evaluation on a particular object regarded as the context of the constraint. For the time being, in this window we can see only those feature calls that returned `false` or `undefined`. In lots of cases this information is enough to eliminate the unwanted errors or to find out where the problem occurred.

Selecting one line in the track window, the **Expression** window and the list showing the defined variables are updated according to the context of the track line.

Note

At this time, tracking of the execution of Constraint Definitions is not available.

10.2.7. Constraints in the model

10.2.7.1. Constraints' types

As GME had introduced the type inheritance concept, it became essential that the user would be able to attach constraints to types and subtypes similarly to kinds.

In GME the set of the rules expressed by constraints defined in the paradigm may be extended by constraints defined by the modeler. These constraints can be associated to types, subtypes, even instances in a specific way.

If the modeler set the aim to create a model, which will be imported as a library into other models, then the constraints defined in the imported model become library constraints. The types of constraints are the following:

Figure 51. Icons for types of Constraints and Definitions

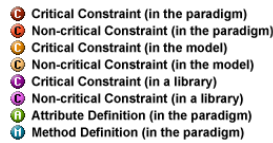

10.2.7.2. Constraint Browser

By executing the **Tools | Display Constraints** command, the user can browse all constraints available in the model in the page **Constraints** of the **Constraint Browser**. The page displays the state (i.e. not available because of errors, well- formed and valid), the type and the full name for each constraint.

Selecting the items in the list and clicking on the **Check** button make the user able to evaluate specific constraint on demand.

Double-clicking on a constraint, the user is able to look at its expression and its other attributes. If the constraint is neither a paradigm-constraint nor a library-constraint, its definition can be changed easily with the exception of the context and the name.

Figure 52. Constraints in the model

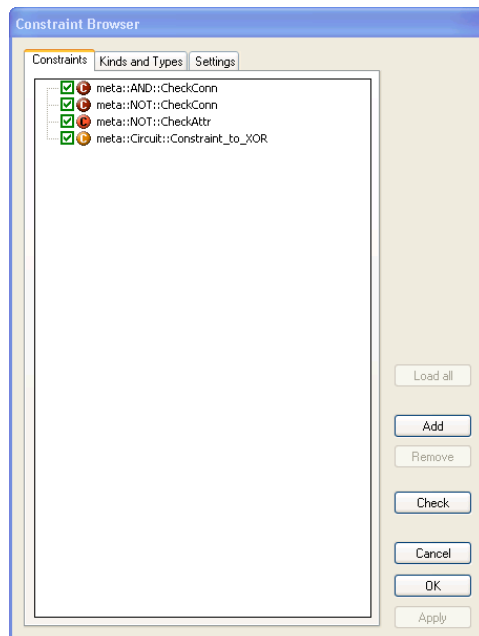

10.2.7.3. Add and Remove constraints

With the **Add** and the **Remove** buttons the user may add and remove constraints from the model. In the model, constraints cannot be either added or removed from the libraries and the paradigm. Constraint Definitions can be created only in the paradigm.

Modeler constraints can be specified similarly to a paradigm's constraints. The context can be only kinds rather than types, subtypes or instances. The set of the objects can be restricted with the constraint enabling mechanism.

10.2.7.4. Enable and disable constraints

Figure 53. Enable constraints – restrict the context of constraints

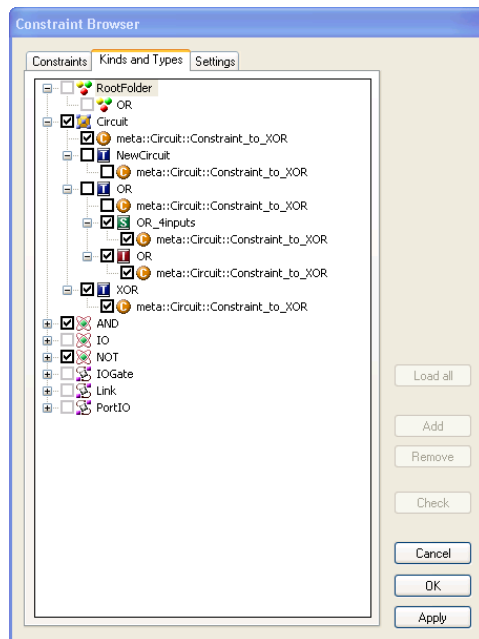

For each object and constraint pair the user may set a special enable flag. If the constraint is disabled for an object, then the constraint will be evaluated on the object only if the user checks it explicitly.

Nevertheless there are some exceptions when the enable flag cannot be changed:

- Critical constraints defined in the paradigm or in a library are always enabled.
- Flags cannot be changed for the objects residing in a library.

The user can change these flags in the **Kinds** and **Types** page of the **Constraint Browser** dialog.

The dialog displays this information in a tree whose root nodes are the kinds. Subnodes of the kinds are types, subtypes and instances according to the type inheritance chain. Each object and each kind have subnodes representing the constraints.

Note

In the beginning, the tree contains special icons instead of checkboxes. These icons are for telling the user that there is no information gathered regarding the kinds. Selecting them or clicking on the **Load All** button will cause the information to become available.

Checkboxes may have different colors. The meaning of the colors are the following:

- Grey – the flag is disabled
- Cyan – the flag's value is inherited, the value is implicit
- Black – the flag's value is set explicitly – not inherited

The checkboxes can enable or disable the constraints in different sort of ranges depending on what kind of nodes they are reside before.

- At kinds – enable all constraints for all objects of the kind at the same time (not stored)
- At types, subtypes or instances – enable all constraints for the specific object at the same time (not stored)
- At constraint subnodes of kinds – enable the specific constraint for all objects of the specific kind.(not stored)
- At constraint subnodes of objects – enable the specific constraint for the specific object. (stored)

Note

It is likely that the user changes a flag for an object (e.g.: for a type) then the color of the checkboxes of the descendant objects will change using the advantage of type inheritance in the registry.

In order to facilitate the context definition the right and left buttons of the mouse can be used:

- Left button – set the flag only for the specific node.
- Right button – set the flag for the specific node and its appropriate subnode according to described relationships above.

10.2.7.5. Constraints in a library

Constraints residing in a library are the same as the constraints in a model, but according to the library's definition the constraints are read-only.

Note

If a library (i.e. the included model) is changed, it has to be included again into the model after deletion or refreshed. After including the library the model has to be closed so that its new constraints will be available for evaluating.

A. OCL and GME

1. OCL Language

In this section we discuss the standard OCL 1.4 structures and expression can be used in GME. We summarize all issues which writing constraints in GME based on.

1.1. Type Conformance

OCL, as specified, is a typed language. The types that can be used in OCL are organized in a type hierarchy. This hierarchy as well as the type inheritance and special properties of meta-types, correspond to conformance rules describing if and how a type conforms to another.

These rules include the following:

Common rules

- A type conforms to itself.
- A type conforms to its supertypes (direct, or indirect supertypes)
- A type conforms to its meta-type.
- A type conforms to supermeta-types of its meta-type.

Compound meta-type related, additional rules (applies to Collection, Set, Bag and Sequence)

- A compound type conforms to another compound type, if its contained type conforms to another's contained type.

Record meta-type related, additional rules (applies to Tuple)

- A tuple conforms to another tuple, if its contained member types conforms to another's contained member types, and these members' names are the same.

Paradigm types related, additional rules

- A type defined in a meta-model (paradigm) conforms to another type from which it is derived. This rule is applicable if and only if inheritance is defined for these types.

These rules are extended, because the next version of OCL will introduce the feature to access meta-kind information.

1.2. Context of a Constraint

As we mentioned earlier, an OCL constraint is always written in the context of a specific type. In this implementation the type can be only a type defined in the paradigm.

The context is always accessible anywhere in a constraint as a special variable called `self`. This is also a reserved keyword of OCL.

A constraint can be evaluated to objects, which are instances of the type of the context. If a constraint evaluates to `false`, the object violates the constraint. If a constraint evaluates to `undefined`, then one or more exceptions were thrown while the constraint was evaluating.

A constraint can be named. In some circumstances, this is a requirement rather than an option, in order to make a distinction between constraints of a type. The constraint's defined name will be the concatenation of the type of the context and the name of the constraint.

In this implementation each constraint expression has to have context declaration. The context declaration differs from constraint type to constraint type.

1.3. Types of Constraints (Expressions)

1.3.1. Invariants

A constraint can be an *Invariant*. An invariant must be true for all instances of the type of the context at any time. In the case of invariants, the special variable - `self` - can be renamed; in this case, `self` is not accessible.

```
"context" { <contextName> ":" } <typeName> "inv" { <constraintName> } ":"
<expression>
e.g.:
context Person inv DontHaveDogs : .....
context p : Person inv : .....
```

1.3.2. Pre-conditions

A constraint can be a *Pre-condition*. A pre-condition can be associated with any behavioral feature. In order to define the context of the constraint, the user has to specify the name, the parameters, and the returned type of the feature.

In a pre-condition, the parameters of the feature can be accessed as variables. Although the original OCL does not allow the renaming of `self` in pre-conditions, this implementation does allow it.

The names of the parameters must be unique, and cannot be either `self` or the name of the context.

For the time being, this constraint type is not fully implemented, because so far it has not been a requirement for GME and UDM.

```
"context" { <contextName> ":" } <typeName> "::" <featureName> "(" {
<paramName> ":" <paramType> ( ";" <paramName> ":" <paramType> )* } ")" { ":"
<typeName> } "pre" { <constraintName> } ":" <expression>
e.g.:
context Person::GetSalary( month : int ) : real pre ValidMonth : .....
context p : Person::CheckOut() pre : .....
```

1.3.3. Post-conditions

A constraint can be a *Post-condition*. A post-condition can be associated with any behavioral feature. In order to define the context of the constraint, the user has to specify the name, the parameters, and the returned type of the feature.

In a post-condition, the parameters of the feature can be accessed as variables, and the returned value can be accessed via a special variable called `result`. Although the original OCL does not allow the renaming of `self` in preconditions, this implementation does allow it.

The names of the parameters must be unique, and cannot be either `self`, `result` or the name of the context.

The special postfix operator - `@pre` - may only be used in a post-condition. This feature is not implemented yet.

For the time being, this constraint type is not fully implemented, because so far it has not been a requirement for GME and UDM.

```
"context" { <contextName> ":" } <typeName> "::" <featureName> "(" {
```



```
<paramName> ":" <paramType> ( ";" <paramName> ":" <paramType> )* } ")" { ":"
<typeName> } "post" { <constraintName> } ":" <expression>
```

e.g.:

```
context Person::GetSalary( month : int ) : real post ValidSalary : .....
context p : Person::CheckIn() post : .....
```

1.3.4. Attribute Definition

This feature of OCL is included here because constraint types must be dealt with in a uniform way. However, an Attribute Definition is not really a constraint. It can be considered an extension of a type in the aspect of constraints.

An attribute definition is an attribute of a type that can be accessed only in OCL constraints. It has the same properties as a well-known attribute. It always has a name and the returned type.

The name must not conflict with other attributes definitions, attributes of the type, or roles and names of types, which can be accessed through navigation.

```
"context" <typeName> ":" <attributeName> ":" <typeName> "defattribute" ":"
<expression>
```

e.g.:

```
context Person::friendNames : Set defattribute : .....
```

1.4. Common OCL Expressions

These expressions are common to every OCL of every meta-paradigm.

As OCL is a query language, it is true for all expressions that objects' states (i.e. values of their member variables) and not modified. It is always true that all expressions must return a value (i.e. an object). OCL is case-sensitive.

1.4.1. Type casting

As OCL is a typed language, it is not allowed to simply call features of an object. A type of the object (and of course the meta-type) defines the kinds of expressions in which the object can participate.

In most cases, the type of the object in a specific expression is enough to write the expression without type casting, but there are some circumstances in which it is necessary.

An object always has dynamic and static type in an expression. The static type is known at the time of writing the expression. The dynamic type is determined at run-time, while the constraint is evaluating.

There are two known situations in which type casting is required:

- The static type of the object differs from the well-known (i.e. dynamic) type of the object. To write certain expressions, the type must be downcast. This is the case when an expression returns an object, but its static type is the supertype of the object's dynamic type.
- The type of the objects, overloads or overrides a feature of a supertype in a certain way (e.g. by inheritance). To access the super type's functionality, the type of the object must be up-cast.

Type casting is defined by the meta-type `ocl::Any`. It declares the type cast operator to be a method called `oclAsType`. This method returns the same object, but with the type it obtains as an argument.

To cast one object's type to another, the former type has to conform to the new type (up-casting) or the new type has to conform to the former type (down-casting). When these types cannot conform, it is a type conformance error, and an exception is thrown, and `undefined` is returned.

The explicit use of `oclAsType` is not required, because some expressions have it implicitly (e.g. `let` expressions, and iterators)

1.4.2. Undefined

In OCL 1.4, `undefined` is a special object, which cannot be written as literal in this implementation.

During evaluation `undefined` can be returned if the result of a feature call is undefined or if an exception is thrown. These two aspects of `undefined` must be distinguished in the new version (i.e. `undefined` is the sole instance of `ocl::Object`, and a new type called `ocl::Error` must be introduced in order to denote exceptions thrown during the evaluation).

In this implementation `undefined` is considered first and foremost as an error. Thus if a feature has to be performed on or with an object that is `undefined`, then the feature is skipped and `undefined` is returned (for example: the user cannot perform an attribute call on `undefined`, or if a method gets `undefined` as argument, then the method is not called).

There are only some features in which `undefined` can participate in (i.e. the result is not always `undefined`):

- `ocl::Any::isUndefined()`
- `operator[=](ocl::Any , ocl::Any)`
- `operator[<>](ocl::Any , ocl::Any)`
- `operator[==](ocl::Any , ocl::Any)`
- `operator[!=](ocl::Any , ocl::Any)`
- `operator[or](ocl::Boolean , ocl::Boolean)`
- `operator[implies](ocl::Boolean , ocl::Boolean)`

1.4.3. Equality and Identity

Two objects are identical if and only if they are stored in the same memory space. Equality of two objects is defined by the objects' types or meta-types. It is not absolutely necessary that two objects, which are equal to each other, are identical as well.

The `ocl::Any` meta-type defines an operator with which the user can test whether objects' identities are the same. This operator is available for all types used in OCL expressions.

For objects with meta-type `ocl::Any` (practically only for `undefined`) identity is the same as equality, but for any other types we have to make a distinction.

In the OCL specification, there is only one operator with which we can express an equality check. There is no special one for identity check.

As we mentioned earlier, technically the `operator =` of `ocl::Any` is for testing identity, but in a simple way this operator can only be used for testing equality, because all types override it with a special meaning of equality.

In some cases we have to test identity definitely, but it is not simple in standard OCL. We have to up-cast the objects to access the functionality defined by `ocl::Any`. This is why we introduced a simplification, `operator ==`.

operator `==` (and its negation, operator `!=`) always tests identity. However operator `=` (and its negation, operator `<>`) always checks equality (standard OCL).

The following are some examples which return `true`, assuming that there is a variable `var` initialized with 5.

```
let var = 5 in
...
var.oclAsType( "ocl::Any" ) = var.oclAsType( "ocl::Any" ) -- 1. Standard way
to test identity
var.oclAsType( "ocl::Any" ) == var.oclAsType( "ocl::Any" ) -- 2. Redundant,
complex, but valid expression, same as 1.
var == var -- 3. Same as 1, short and
compact form of 1.
not var != var -- 4. Meaning of operator !=
var != 5 -- 5. Because 5 is stored in
different memory space as var's value
var = 5 -- 6. Equality of integers
not var <> 5 -- 7. Non-equality of
integers
5 != 5 -- 8. Two fives are in
different memory spaces.
```

During the evaluation of an OCL expression, none of the objects are altered after they receive a value (i.e. they are initialized). This is a consequence of query languages.

In OCL, all features of types return a different object (not identical), even if it is possible for them to return the same object (identical).

For example, method `ocl::Set::including()` receives an object, adds it to the set, and returns a set. The two sets are not identical, but the object which is included in the new set is identical to the argument of the method, because it was not altered.

We must note here that in all features depending on identity or equality check, equality is always applied. We will indicate explicitly if an identity check is used, or if the identity of an object is not changed during the evaluation (i.e. a new object is not created in memory).

1.4.4. Literals

For the time being, two kinds of literals exist: literals of data-types predefined by OCL, and literals of compound types.

Because basic primitive types are well-known, their literals are discussed through examples.

```
"string", "\r\n: <CR><LF>", "" -- String literals
0.0, -1.0, 5.232, -234.232 -- Real literals (reals are represented
as 64bit long signed floating-point numbers)
0, -1, 5, 2131 -- Integer literals (integers are
represented as 64bit long signed integer numbers)
#enabled, #disabled, #unknown -- Enumeration literals (enumeration values
begins with # character)
true, false -- Boolean literals
```

Compound types' literals are a bit more complex than primitive types' literals. The user has to write the name of the compound type followed by the list of expressions enclosed by braces (the list can be empty). Objects returned by the expressions will be the elements of the compound object.

In standard OCL range of object (using operator `..`) can be specified. In this implementation it is not supported yet.

Compound types are so far limited to: `Collection`, `ocl::Collection`, `Set`, `ocl::Set`, `Bag`, `ocl::Bag`, `Sequence`, `ocl::Sequence`.

```
<compoundType> "{" { <expression> ( "," <expression> )* } "}"
```

e.g.

```
Sequence{ 0, 1, 2, "23", true }
```

1.4.5. Let expression

A *Let* expression performs variable declaration and initialization.

This expression has two parts. The first part declares and initializes the variable, the second part declares where this variable is accessible. Let expression's return type is the same type as the second expression.

Variables in OCL can be used to make the constraint more readable or to improve the performance of constraint evaluation. If we want to use a result of an expression more than once, it is better to compute the result only once and store it in a variable.

Let expression may have a type declaration, as well.

```
"let" <variableName> { ":" <declarationType> } "=" <expression> "in"
<expression>
```

e.g. in GME

```
let dogs = persons.connectedFCOs( "src", "Partners" ) in .....
```

1.4.6. If Then Else Expression

This expression is the well-known "if" feature of languages, with a limitation that it always has an else branch. Otherwise if the condition is not satisfied, the result would be unknown.

The If expression consists of three expressions:

- The condition which has to return `ocl::Boolean` or any of its descendants (if they exist).
- Two expressions with the same return type (i.e. then and else branches)

If the condition evaluates to `true`, then only the first expression will be evaluated; otherwise, only the second will be evaluated.

```
"if" <condition> "then" <expression> "else" <expression> "endif"
```

e.g.

```
if mySet -> isEmpty() then 0 else mySet -> size endif
```

1.4.7. Iterators

Although *Iterator* is a special feature defined by `ocl::Compound` meta-type, it is discussed in this subsection because `ocl::Compound` is defined by OCL and not by meta-paradigms, and because there is a special, generic iterator called `iterate`. Only `ocl::Collection` and its descendant types have this feature.

An iterator can be considered to be a cycle, which iterates over the elements of a compound object while it evaluates the expression obtained as an argument for each element and returns a value accumulated during the iteration.

Iterators (may) have:

- A typed expression, which will be evaluated for each element (mandatory).
- A return type, which is the type of the accumulated object (mandatory). It is not necessary for this type is to match the type of the argument.

- Declarators, which are variables that refer to the current element of the iteration process (optional).
- A declaration type, which is simply an implicit type cast (optional).

These are true only for predefined iterators discussed in a later section.

```
<expression> "->" <iteratorName> "(" { <declarator> ( "," <declarator> )* {
":" <declarationType> } } "|" <expression> ")"
```

```
e.g.
let mySet = Set { "1", "2", "3", "10" } in
...
mySet -> forAll( elem1, elem2 : int | elem1 <> elem2 )
mySet -> one( size = 2 )
```

Here we discuss only the generic iterator of OCL called `iterate`.

`Iterate` always has a variable that is regarded as the accumulator of the iteration. The iterator's return type is the type of the accumulator. The accumulator is always initialized. The expression has to include the accumulator variable so that the iteration will be meaningful (but it is not required). `Iterate` may have exactly one declarator.

`Iterate` is the foundation of all predefined iterator.

```
<expression> "->" "iterate" "(" { <declarator> { ":" <declarationType> } ";"
} <accumulator> { ":" <accumulatorType> } "=" <expression> "|" <expression>
)"
```

```
e.g.
let mySet = Set { "1", "2", "3", "10" } in

-- Expressing the functionality of "exists" predefined iterator
mySet -> exists( i | i.size = 2 )
mySet -> iterate( i ; accu = false | accu or i.size = 2 )

-- Expressing the functionality of "isUnique" predefined iterator
mySet -> isUnique( i | i )
mySet -> forAll( i1, i2 | i1 != i2 implies i1 <> i2 )
mySet -> iterate( i1 ; accu1 = true | accu1 and mySet -> iterate( i2 ; accu2
= true | accu2 and ( i1 != i2 implies i1 <> i2 ) ) )
```

1.5. Type Related Expressions

1.5.1. Operators

In OCL, there are a bunch of operators defined by predefined types.

In both OCL 1.4 and OCL 2.0, logical operators are not defined completely, as the specification does not define precedence between these operators. This small lack would make writing OCL expressions more difficult, because the user would have to use parenthesis even if it was not necessary. In this implementation we define the precedence and the associative rules of operators as they are defined in well-known programming languages.

Operators can be overloaded and defined for types of paradigms as well. This extension is adopted from the C++ language. The overridden operators can be accessed by applying the `oclAsType` method of `ocl::Any`. Exceptions to this rule are the primary operators (first row of the table below).

The precedence (from the highest to lowest) and associativity are shown in the following table.

Table A.1.

Operators	Associativity
(), @pre, .., ->	Left to right
- (sign)	Right to left
*, /, div, mod, %	Left to right
+, -	Left to right
<, <=, >, >=, =, <>, ==, !=	Left to right
not	Right to left
and, &&	Left to right
xor	Left to right
or,	Left to right
implies, =>	Right to left

In this implementation, we allow short-circuit logical operators (&&, ||, =>). They can be useful when the user wants to alter the process of the evaluation.

```
<expression> <binaryOperator> <expression>
<unaryOperator> <expression>
```

```
e.g.
"This forms" + " a string"
not person.isRetired()
```

1.5.2. Functions

Although OCL is based on the object-oriented concept, functions can be defined to make OCL more convenient.

There are two examples for this:

- We write `max(a , b)` instead of `a.max(b)`. Of course, both forms of these calls are available.
- In extensions of OCL, it is good practice to somehow separate the extending features from the standard ones. This issue can be solved very well with functions, though it is not necessary.

Functions may have arguments, which are evaluated before calling the function. Arguments may be optional, as in many programming languages. Optional arguments can be followed only by other optional arguments. Arguments omitted in a call are considered to be `undefined`.

There are some predefined functions in OCL, in particularly for `ocl::Real` and `ocl::Integer`.

```
<functionName> "(" { <expression> ( "," <expression> )* } ")"
```

```
e.g.
floor( 3.14 )
```

1.5.3. Attributes

The simplest features of a type are attributes.

Attributes are defined by the type or by the meta-type. It is also possible that an attribute is not defined by either type or meta-type, but by a constraint attribute definition.

Attributes are not typical of predefined types; there is only one, called `size`.

In OCL, depending on the type of the elements, a special feature can be applied to compound objects which looks like an attribute call. This feature is a shortcut for the special usage of a predefined iterator (`collect`). It is introduced in OCL because of convenience.

We describe it with an example below. These attributes exist if and only if the object contained by the compound object has them.

```
<expression> ( "." | "->" ) <attributeName>

-- Assuming that there is a Set mySet which consists objects with type Person
(Person has an attribute, called age)
-- The result is the same in both cases (a Bag consisting integers - age of
persons)

mySet -> collect( person : Person | person.name )
mySet -> name
```

In some circumstances, attributes of the compound object and the contained object are ambiguous. Then the decision is made (i.e. which attribute is called) depending on the member selection operator.

1.5.4. Methods

Methods are the most generic feature of a type.

A method may have arguments, which are evaluated before calling the method on an object. Arguments may be optional as in many programming languages. Optional arguments can be followed only by other optional arguments. Arguments omitted in a call are considered to be `undefined`.

Methods are defined by the type or by the meta-type. Only those methods, which do not alter the state of the object can be used in OCL. It is also possible that a method is not defined by either type or meta-type, but by a constraint method definition.

If a method has only one argument and belongs to a compound object, then it is possible that it will be ambiguous with a predefined iterator (which does not have any declarators). In this case the member selection operator will be used to call either the method or the iterator.

```
<expression> ( "." | "->" ) <methodName> "(" { <expression> ( "," <expression> )* } ")"
```

e.g.
`object.isUndefined()`

1.5.5. Associations

Associations are usually defined by the types of a paradigm. In OCL associations appear as association-ends.

The result of navigation over an association depends on the multiplicity of another association-end and on the ordered stereotype of the association.

If the multiplicity is `0..1` or `1`, the result is one object. Otherwise the result is an `ocl::Sequence` or an `ocl::Set` depending on whether the association is ordered or not.

The user can navigate from an object to the other side of the association using the role of the association-end. If the role is missing, then the name of the type at the association-end, starting with a lowercase character, is used as role.

In standard OCL, if a navigation (using role) is ambiguous, then the association-end can be accessed by the name of the type at the association-end. If the names of the types are ambiguous as well, then this navigation is not available.

From an association-end, the association class(es) can be accessed using the name of the association class, starting with a lowercase character. If the association is recursive, then the role of the starting point (i.e. association-end) has to follow the name of the association class in brackets. If the roles are ambiguous, then the association class is not accessible.

To navigate from the association class to association-end, the role of the association-end has to be used. If it is ambiguous, then the name of the type at the association-end must be used. The ambiguity rules are the same as before. Navigating from the association class always results in one object (a consequence of the definition of the association class).

Composition is considered to be a special association, but there is no difference in OCL.

In extensions of OCL, it is likely that features defined by meta-types are mapped to special associations with special roles.

The ambiguity rules can be eased, by extensions of OCL, but it may lead to errors in those implementations, because they follow the strict rules of OCL.

```
<expression> "." <roleName>
<expression> "." <typeName> { "[" <roleName> "]" }
```

Here are some examples to facilitate the understanding of navigation over associations.

Figure A.1. Example for associations..

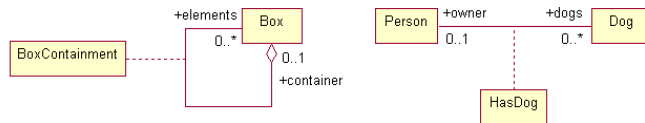

Regarding these parts of a paradigm, the following OCL expression can be written:

```
-- Assuming that "b" is a Box, "bc" is a BoxContainment
-- If Box had further association, which has "elements" or "container" roles,
then these roles could not be used because of ambiguity.

-- Cannot be used in any cases because of recursive containment.
b.box
-- Returns in ocl::Set( Box ). If "elements" was missing, that association-
end would not be accessible from Box.
b.elements
-- Returns in Box. If "container" was missing, that association-end would not
be accessible from Box.
b.container
-- Cannot be used in any cases because of recursive containment.
b.boxContainment
-- Returns in ocl::Set( BoxContainment ). If "container" was missing, that
association-class would not be accessible from Box as container.
b.boxContainment[ container ]
-- Returns in BoxContainment. If "elements" was missing, that association-
class would not be accessible from Box as element.
b.boxContainment[ elements ]
-- Cannot be used in any cases because of recursive containment.
bc.box
-- Returns in Box. If "elements" was missing, that association-end would not
be accessible from BoxContainment.
```



```
bc.elements
-- Returns in Box. If "container" was missing, that association-end would not
be accessible from BoxContainment.
bc.container
-- Assuming that "p" is a Person, "d" is a Dog, "hd" is a HasDog
-- If Person, Dog, HasDog had further association, which has "owner" or
"dogs" roles, then these roles could not be used because of ambiguity.
-- If these classes have further association between them, then the name of
the appropriate classes cannot be used as role.
-- If role exists, then the role has to be used to navigate, otherwise the
name of class has to be used.

-- Returns in ocl::Set( Dog ).
p.dogs
p.dog
-- Returns in Person.
d.owner
d.person
-- Returns in ocl::Set( HasDog ).
p.hasDog
-- Returns in HasDog.
d.hasDog
-- Returns in Dog.
hd.dogs
hd.dog
-- Returns in Person.
hd.owner
hd.person
```

1.5.6.

1.5.7.

1.5.8.

1.6. Resolution Rules

1.6.1. Implicit Variables

In standard OCL, implicit variables are introduced. These variables are similar to this in C++ or Java, thus they can be omitted to prevent writing long expressions.

The variable of the context – in many cases: `self` – is always implicit. Other implicit variables are created by iterators, which do not have any declarators.

Because of this property of the language the resolution of features (i.e. expressions) gets more complicated.

In an expression all available implicit variables are marked and stored in a sequence. If an expression has to be regarded as a feature of a type (i.e. attribute, association- end, method, iterator), then all implicit variables are examined to determine which variable the feature belongs to. This examination starts at the end of the sequence and goes to the beginning (i.e. the variable declared last is examined first). If a feature is resolved (even if it is ambiguous), then resolution is stopped.

```
-- Assuming that "Person" and "Dog" are defined by the paradigm. They have an
association called "HasDog" with roles "owner" and "dogs".
-- Both classes have an attribute called "age". Person has an attribute
called "gender".
```

```

-- First "age" is resolved as "self.age", because there is only one implicit
variable called "self".
-- "dogs" is resolved as "self.dogs", because there is only one implicit
variable called "self".
-- Iterator called "forAll" creates a new implicit variable. We refers to
that as "iter1". These variables are not accessible in the expression
directly.
-- "gender" is resolved "self.gender", because "iter1" which is a Dog, does
not have any feature called "gender".
-- Second and third "age" is resolved as "iter1.age", because "iter1" is
defined latter than "self", i.e. the examination started with "iter1".
-- "owner" is resolved as if it had been written "iter1.owner" where iter1 is
an implicit declarator created by the iterator
    context Person inv :
    age < 4 implies dogs -> forAll( if gender = #male then age < 1 else age <
0.5 endif )

-- Assuming that "Box" is defined by the paradigm. Box has a containment with
roles "container" and "elements".
-- Box has a query method called "includes" with one argument with type Box.
-- The example does not make sense, it demonstrates the resolution only.

-- First "elements" is resolved as "self.elements", because there is only one
implicit variable called "self".
-- Iterator called "collect" creates a new variable. We refers to that as
"iter1". These variables are not accessible in the expression directly.
-- Second "elements" is resolved as "iter1.elements", because "iter1"
precedes "self" during the resolution, and it is a Box.
-- Type of "boxes" will be ocl::Bag( ocl::Set( Box ) ).
-- In the third line "boxes" and "self" are not subject of resolution because
they are known variables.
-- Iterator called "forAll" creates a new implicit variable. We refers to
that as "iter1". Former "iter1" exists in the context of "collect" only.
-- First "includes" resolved as "iter1.includes( ocl::Any )", because type of
"iter1" is ocl::Set( Box ), and ocl::Set has a method called "includes".
-- Iterator called "exists" creates a new implicit variable. We refers to
that as "iter1". Former "iter1" exists in the context of "forAll" only.
-- "one" is resolved as "iter1.one( ocl::Boolean )", because type of "iter1"
is ocl::Set( Box ), and ocl::Set has an iterator called "one".
-- The resolved iterator called "one" creates a new implicit variable. We
refers to that as "iter2".
-- Second "includes" resolved as "iter2.includes( Box )", because "iter2"
precedes "iter1" and the type of "iter2" is Box.
-- "size" is resolved as "iter1.size", because the type of "iter2" (Box) does
not have any feature called "size", but "iter1".
    context Box inv :
    let boxes = self.elements -> collect( iter1.elements ) in
    boxes -> forAll( not includes( self ) ) and boxes -> exists( one(
includes( self ) or size = 0 ) )

```

1.6.2. Expression Resolution

In an OCL expression it is likely that a text can be resolved differently depending on the context (e.g. declared (implicit) variables, defined types, existing features of types, etc.).

The rules of the resolution are described below. These differ for different sort of texts and expressions.

In the description, we assume that the paradigm is well-formed and valid.

Resolving a text which looks like an identifier:

1. Check whether a type exists whose name is <id>. If there is such a type, resolution is stopped.
2. Check whether there is a variable called <id>. If there is such a variable, resolution is stopped.

3. Check whether an implicit object (implicit variable) has features which can look like `<id>`.
 - If an implicit object has exactly one feature, then resolution is stopped.
 - If the object has more features, then resolution is stopped, and an exception is thrown because of ambiguity caused by features with the same names.
4. Resolution ends and an exception is thrown because `<id>` cannot be resolved.

Resolving a text which looks like a function:

1. Check whether there is a function matching `<function>`. If there is such a function, resolution is stopped.
2. Check whether an implicit object (implicit variable) has features which can look like `<function>`.
 - If an implicit object has exactly one feature, then resolution is stopped.
 - If the object has more features, then resolution is stopped, and an exception is thrown because of ambiguity caused by features with the same signatures.
3. Resolution ends and an exception is thrown because `<function>` cannot be resolved.
- 4.

Resolving an expression which looks like an attribute call:

1. Check whether the object has an attribute called `<attribute>`.
2. Check whether the object has access to an association-end whose role (or type considered as role) looks like `<attribute>`.
3. If the object comes from an implicit variable:
 - If exactly one feature is found, resolution is stopped.
 - If more features are found, then resolution is stopped, and an exception is thrown because there are more features which can be accessed in the same way.
 - Resolution ends and an exception is thrown because `<attribute>` cannot be resolved.
4. If the object comes from an expression (i.e. member selection operator is used)
 - If exactly one feature is found, resolution is stopped.
 - If two attributes are found (i.e. an attribute of the compound object and an attribute of the contained objects), then resolution is stopped. If the member selection operator is “.”, then the compound object's attribute is resolved, otherwise the other attribute is resolved.
 - If an attribute and an association-end are found (in this case the object is not compound, because it cannot have associations), then resolution is stopped and an exception is thrown because of ambiguity.
 - Resolution ends and an exception is thrown because `<attribute>` cannot be resolved.

Resolving an expression which looks like a method call:

1. Check whether the object has a method which can be called as `<method>`.

2. If the object is compound, check whether the object has an iterator which can be called as `<method>`.
3. If the object comes from an implicit variable:
 - If exactly one feature is found, the resolution is stopped.
 - If more features are found, then the resolution is stopped, and an exception is thrown because there are more features which can be accessed in the same way.
 - Resolution ends and an exception is thrown because `<method>` cannot be resolved.
4. If the object comes from an expression (i.e. member selection operator is used)
 - If exactly one feature is found, the resolution is stopped.
 - If a method and an iterator are found (in this case the object is compound, because only compound objects can have iterators), then the resolution is stopped. If the member selection operator is “.”, then the method is resolved, otherwise the iterator is resolved.
5. Resolution ends and an exception is thrown because `<method>` cannot be resolved.

1.6.3.

2. Predefined OCL Types

For the time being, `ocl::Any` is considered to be a type, and further meta-types are not defined. In the next version these meta-types will be accessible as well as meta-kind information.

The types enumerated below are accessible in all OCL expressions.

2.1. `ocl::Any`

The type `ocl::Any` is the supertype of all types used in OCL expressions. Features associated with `ocl::Any` can be used for all types.

This type has only one instance, which is undefined.

2.1.1. Aliases, Supertypes

This type can also be accessed as `Any`.

2.1.2. Operators

```
operator[ == ]( any1 : ocl::Any , any2 : ocl::Any ) : ocl::Boolean
operator[ = ]( any1 : ocl::Any , any2 : ocl::Any ) : ocl::Boolean
```

Returns `true` if `any1` is the same as `any2`. This equality means identity. `any1` or `any2` may be undefined. If only one of them is undefined, then the result is `false`; if both of them are undefined, the result is `true`.

```
operator[ != ]( any1 : ocl::Any , any2 : ocl::Any ) : ocl::Boolean
operator[ <> ]( any1 : ocl::Any , any2 : ocl::Any ) : ocl::Boolean
```

Returns `true` if `any1` is not the same as `any2`. This equality means identity. `any1` or `any2` may be undefined. If only one of them is undefined, then the result is `true`; if both of them are undefined, the result is `false`.

2.1.3. Methods

```
ocl::Any::oclIsTypeOf( type : ocl::Type ) : ocl::Boolean
```

Returns `true` if `any` is an instance of `type`.

`type` can be a simple name, but not a compound name. So far this method cannot be used to check type conformity, “`ocl::Set(ocl::Any)`” as argument is invalid, only “`ocl::Set`” is valid. If the specified type is invalid or if there is no type having this name, the method throws an exception and returns undefined.

```
ocl::Any::oclIsKindOf( type : ocl::Type ) : ocl::Boolean
```

Returns `true` if `any` is an instance of `type` or if any descendants of `type`. For further information, see `ocl::Any::oclIsTypeOf()`.

```
ocl::Any::oclAsType( type : ocl::Type )
```

This is actually a static typecast operator. It returns the same object with `type` (i.e. it does not create a new object, the result is identical to the object itself).

The object's type has to conform to the `type`, or vice-versa. This method can be used to access overridden and overloaded features defined by ascendants of a type (up- cast), or it can be used for the well-known down-cast.

Note

`type` can be a simple name, but a compound name. So far this method cannot be used to check type conformity, “`ocl::Set(ocl::Any)`” as an argument is invalid, only “`ocl::Set`” is valid. If the specified type is invalid or if there is no type having this name, the method throws an exception and returns undefined.

```
ocl::Any::isUndefined() : ocl::Boolean
```

Returns true if the object is undefined. This method can be used to test whether an object is undefined or not, and to handle exceptions thrown by an OCL expression.

2.2. ocl::String

The type `ocl::String` represents ASCII strings, as specified in OCL.

2.2.1. Aliases, Supertypes

This type can be accessed as `string`. Its supertype is `ocl::Any`.

2.2.2. Operators

```
operator[ = ]( string1 : ocl::String , string2 : ocl::String ) : ocl::Boolean
```

Returns true if `string1` is the same character sequence as `string2`.

```
operator[ <> ]( string1 : ocl::String , string2 : ocl::String ) : ocl::Boolean
```

Returns true if `string1` is not the same character sequence as `string2`.

```
operator[ + ]( string1 : ocl::String , string2 : ocl::String ) : ocl::String
```

Returns a `string` that is the concatenation of `string1` and `string2`.

```
operator[ < ]( string1 : ocl::String , string2 : ocl::String ) : ocl::Boolean
```

Returns true if `string1` is ahead of `string2` in lexicographical ordering.

```
operator[ <= ]( string1 : ocl::String , string2 : ocl::String ) : ocl::Boolean
```

Returns true if `string1` is ahead of or equal to `string2` in lexicographical ordering.

```
operator[ > ]( string1 : ocl::String , string2 : ocl::String ) : ocl::Boolean
```

Returns true if `string2` is ahead of `string1` in lexicographical ordering.

```
operator[ >= ]( string1 : ocl::String , string2 : ocl::String ) : ocl::Boolean
```

Returns true if `string2` is ahead of or equal to `string1` in lexicographical ordering.

2.2.3. Attributes

```
ocl::String::size : ocl::Integer
```

Returns the length of the string.

2.2.4. Methods

```
ocl::String::concat( string : ocl::String ) : ocl::String
```

Returns a `string`, which is the concatenation of `this` and `string`. This is the same as the operator `+`.

```
ocl::String::toUpper( ) : ocl::String
```

Returns a `string` containing only uppercase characters.

```
ocl::String::toLower( ) : ocl::String
```

Returns a `string` containing only lowercase characters.

```
ocl::String::substring( start : ocl::Integer {, length : ocl::Integer } ) :  
ocl::String
```

Returns the sub-string of `this` beginning at `start` and having a specified `length`. If `length` is not specified, the substring continues to the end of `this`. If `length` is zero or negative, an empty `string` is returned. The first position is 0. The result is undefined and an exception is thrown if `lower` is less than 0.

```
ocl::String::trim( ) : ocl::String
```

Returns a `string` that neither starts nor ends with white-space characters. “\t”, “ ”, “\r”, “\t” and characters “\u0000” to “\u0020” are considered to be white-space.

```
ocl::String::toReal( ) : ocl::Real
```

Converts `this` to `ocl::Real`. If the conversion cannot be performed, then an exception is thrown and the method returns undefined. The method cannot convert strings representing real numbers, but an exponent.

```
ocl::String::toInteger( ) : ocl::Integer
```

Converts `this` to `ocl::Integer`. If the conversion cannot be performed, then an exception is thrown and the method returns undefined. The method cannot convert strings representing integer numbers, but an exponent.

2.3. ocl::Enumeration

The type `ocl::Enumeration` represents types with a discrete and finite value domain.

2.3.1. Aliases, Supertypes

This type can be accessed as `enum`. Its supertype is `ocl::Any`.

2.3.2. Operators

```
operator[ = ]( enum1 : ocl::Enumeration , enum2 : ocl::Enumeration ) : ocl::Boolean
```

Returns `true` if `enum1` is the same value as `enum2`.

```
operator[ <> ]( enum1 : ocl::Enumeration , enum2 : ocl::Enumeration ) :  
ocl::Boolean
```

Returns `true` if `enum1` is not the same value as `enum2`.

2.4. ocl::Boolean

The type `ocl::Boolean` represents the logical type of OCL.

2.4.1. Aliases, Supertypes

This type can be accessed as `bool`. Its supertype is `ocl::Any`.

2.4.2. Operators

```
operator[ = ]( bool1 : ocl::Boolean , bool2 : ocl::Boolean ) : ocl::Boolean
```

Returns true if `bool1` equals to `bool2`.

```
operator[ <> ]( bool1 : ocl::Boolean , bool2 : ocl::Boolean ) : ocl::Boolean
```

Returns true if `bool1` does not equal to `bool2`.

```
operator[ and ]( bool1 : ocl::Boolean , bool2 : ocl::Boolean ) : ocl::Boolean
```

```
operator[ && ]( bool1 : ocl::Boolean , bool2 : ocl::Boolean ) : ocl::Boolean
```

Returns true if `bool1` and `bool2` are true. Returns undefined if `bool1` or `bool2` are undefined. Operator `&&` is a short-circuit operator. If `bool1` is false or undefined, `bool2` will not be evaluated.

```
operator[ or ]( bool1 : ocl::Boolean , bool2 : ocl::Boolean ) : ocl::Boolean
```

```
operator[ || ]( bool1 : ocl::Boolean , bool2 : ocl::Boolean ) : ocl::Boolean
```

Returns true if `bool1` or `bool2` are true. Returns undefined if `bool1` and `bool2` are undefined. Operator `||` is a short-circuit operator. If `bool1` is true, `bool2` will not be evaluated.

```
operator[ implies ]( bool1 : ocl::Boolean , bool2 : ocl::Boolean ) : ocl::Boolean
```

```
operator[ => ]( bool1 : ocl::Boolean , bool2 : ocl::Boolean ) : ocl::Boolean
```

Returns true if `bool1` is false or if both operands are true. Returns undefined if `bool1` or `bool2` are undefined. Operator `=>` is a short-circuit operator. If `bool1` is false or undefined, `bool2` will not be evaluated.

```
operator[ not ]( bool : ocl::Boolean ) : ocl::Boolean
```

Returns true if `bool` is false. Returns undefined if `bool` is undefined.

2.5. ocl::Real

The type `ocl::Real` represents the mathematical concept of real.

2.5.1. Aliases, Supertypes

This type can be accessed as `real` or `double`. Its supertype is `ocl::Any`.

2.5.2. Operators

```
operator[ = ]( real1 : ocl::Real , real2 : ocl::Real ) : ocl::Boolean
```

Returns true if `real1` is equal to `real2`.

```
operator[ <> ]( real1 : ocl::Real , real2 : ocl::Real ) : ocl::Boolean
```

Returns true if `real1` is not equal to `real2`.

```
operator[ < ]( real1 : ocl::Real , real2 : ocl::Real ) : ocl::Boolean
```

Returns true if `real1` is less than `real2`.

`operator[<=](real1 : ocl::Real , real2 : ocl::Real) : ocl::Boolean`

Returns true if `real1` is less than or equal to `real2`.

`operator[>](real1 : ocl::Real , real2 : ocl::Real) : ocl::Boolean`

Returns true if `real1` is greater than `real2`.

`operator[>=](real1 : ocl::Real , real2 : ocl::Real) : ocl::Boolean`

Returns true if `real1` is greater than or equal to `real2`.

`operator[-](real : ocl::Real) : ocl::Real`

Returns a `real` which is the opposite of `real`, or 0.0 if `real` is 0.0.

`operator[+](real1 : ocl::Real , real2 : ocl::Real) : ocl::Real`

Returns a `real` which is the addition of `real1` and `real2`.

`operator[-](real1 : ocl::Real , real2 : ocl::Real) : ocl::Real`

Returns a `real` which is the subtraction of `real1` and `real2`.

`operator[*](real1 : ocl::Real , real2 : ocl::Real) : ocl::Real`

Returns a `real` which is the multiplication of `real1` and `real2`.

`operator[/](real1 : ocl::Real , real2 : ocl::Real) : ocl::Real`

Returns `real1` divided by `real2`.

2.5.3. Functions

`abs(real : ocl::Real) : ocl::Real`

Return the absolute value of `real`.

`floor(real : ocl::Real) : ocl::Integer`

Returns the largest integer which is less than or equal to `real`.

`round(real : ocl::Real) : ocl::Integer`

Returns the closest integer to `real`. If there are two of them, then it returns the largest one.

`max(real1 : ocl::Real , real2 : ocl::Real) : ocl::Real`

Returns the maximum of `real1` and `real2`.

`min(real1 : ocl::Real , real2 : ocl::Real) : ocl::Real`

Returns the minimum of `real1` and `real2`.

2.5.4. Methods

`ocl::Real::abs() : ocl::Real`

Returns the absolute value of `this`.

`ocl::Real::floor() : ocl::Integer`

Returns the largest integer which is less than or equal to `this`.

```
ocl::Real::round( ) : ocl::Integer
```

Returns the closest integer to this. If there are two of them, then it returns the largest one.

```
ocl::Real::max( real : ocl::Real ) : ocl::Real
```

Returns the maximum of this and real.

```
ocl::Real::min( real : ocl::Real ) : ocl::Real
```

Returns the minimum of this and real.

2.6. ocl::Integer

The type `ocl::Integer` represents the mathematical concept of integer.

2.6.1. Aliases, Supertypes

This type can be accessed as `int` or `long`. Its supertype is `ocl::Real`.

2.6.2. Operators

```
operator[ = ]( int1 : ocl::Integer , int2 : ocl::Integer ) : ocl::Boolean
```

Returns true if int1 is equal to int2.

```
operator[ <> ]( int1 : ocl::Integer , int2 : ocl::Integer ) : ocl::Boolean
```

Returns true if int1 is not equal to int2.

```
operator[ < ]( int1 : ocl::Integer , int2 : ocl::Integer ) : ocl::Boolean
```

Returns true if int1 is less than int2.

```
operator[ <= ]( int1 : ocl::Integer , int2 : ocl::Integer ) : ocl::Boolean
```

Returns true if int1 is less than or equal to int2.

```
operator[ > ]( int1 : ocl::Integer , int2 : ocl::Integer ) : ocl::Boolean
```

Returns true if int1 is greater than int2.

```
operator[ >= ]( int1 : ocl::Integer , int2 : ocl::Integer ) : ocl::Boolean
```

Returns true if int1 is greater than or equal to int2.

```
operator[ - ]( int : ocl::Integer ) : ocl::Integer
```

Returns an integer which is the opposite of int, or 0 if int is 0.

```
operator[ + ]( int1 : ocl::Integer , int2 : ocl::Integer ) : ocl::Integer
```

Returns an integer which is the addition of int1 and int2.

```
operator[ - ]( int1 : ocl::Integer , int2 : ocl::Integer ) : ocl::Integer
```

Returns an integer which is the subtraction of int1 and int2.

```
operator[ * ]( int1 : ocl::Integer , int2 : ocl::Integer ) : ocl::Integer
```

Returns an integer which is the multiplication of int1 and int2.

```
operator[ div ]( int1 : ocl::Integer , int2 : ocl::Integer ) : ocl::Integer
```

Returns the number of times that `int2` fits completely within `int1`.

```
operator[ mod ]( int1 : ocl::Integer , int2 : ocl::Integer ) : ocl::Integer
```

Returns the modulo of `int1` and `int2`.

2.6.3. Functions

```
abs( int : ocl::Integer ) : ocl::Integer
```

Returns the absolute value of `int`.

```
max( int1 : ocl::Integer , int2 : ocl::Integer ) : ocl::Integer
```

Returns the maximum of `int1` and `int2`.

```
min( int1 : ocl::Integer , int2 : ocl::Integer ) : ocl::Integer
```

Returns the minimum of `int1` and `int2`.

2.6.4. Methods

```
ocl::Integer::abs( ) : ocl::Integer
```

Returns the absolute value of `this`.

```
ocl::Integer::max( int : ocl::Integer ) : ocl::Integer
```

Returns the maximum of `this` and `int`.

```
ocl::Integer::min( int : ocl::Integer ) : ocl::Integer
```

Returns the minimum of `this` and `int`.

2.7. ocl::Type

The type `ocl::Type` represents the types and the meta-types used in an OCL expression. For the time being, this type does not have features (e.g. enumerating the attribute of the type), but this type will be the foundation of obtaining meta-kind information in OCL. At the moment, it is used only to refer to types, and meta-types with strings.

2.7.1. Aliases, Supertypes

This type can be accessed as `Type`. Its supertype is `ocl::Any`.

2.7.2. Operators

```
operator[ = ]( type1 : ocl::Type , type2 : ocl::Type ) : ocl::Boolean
```

Returns true if `type1` is equal to `type2`.

```
operator[ <> ]( type1 : ocl::Type , type2 : ocl::Type ) : ocl::Boolean
```

Returns true if `type1` is not equal to `type2`.

2.8. ocl::Collection

The type `ocl::Collection` represents the supertype of `ocl::Set`, `ocl::Sequence` and `ocl::Bag`.

2.8.1. Aliases, Supertypes

This type can be accessed as `Collection`. Its supertype is `ocl::Any`.

2.8.2. Attributes

```
ocl::Collection::size : ocl::Integer
```

Returns the number of elements in the collection.

2.8.3. Methods

There are methods which depend on the equality. In these methods, equality is used rather than identity.

Some methods return different types depending on the context. For example, if the user includes a `real` in a collection containing `integers`, then the method returns a collection of `reals`, because the common ascendant type of `ocl::Real` and `ocl::Integer` is `ocl::Real`. This effect comes from OCL 1.4 inconsistency. In OCL 2.0, this aspect of collections is better defined.

```
ocl::Collection::isEmpty( ) : ocl::Boolean
```

Returns `true` if the collection does not contain any elements.

```
ocl::Collection::notEmpty( ) : ocl::Boolean
```

Returns `true` if the collection contains at least one element.

```
ocl::Collection::includes( any : ocl::Any ) : ocl::Boolean
```

Returns `true` if the collection contains any.

```
ocl::Collection::excludes( any : ocl::Any ) : ocl::Boolean
```

Returns `true` if the collection does not contain any.

```
ocl::Collection::count( any : ocl::Any ) : ocl::Integer
```

Returns the number of times that any occurs in the collection.

```
ocl::Collection::includesAll( collection : ocl::Collection ) : ocl::Boolean
```

Returns `true` if the collection contains all elements of `collection`.

```
ocl::Collection::excludesAll( collection : ocl::Collection ) : ocl::Boolean
```

Returns `true` if the collection does not contain any elements of `collection`.

```
ocl::Collection::sum( ) : <innerType>
```

This method is not implemented yet. It returns the sum of all elements of the collection. Operator `+` must be defined between each element.

```
ocl::Collection::asSet( ) : ocl::Set
```

Returns a set which contains the same elements as the collection, without multiplicity. If the collection is an instance of `ocl::Set`, then the method returns the set itself without creating a new set.

```
ocl::Collection::asSequence( ) : ocl::Sequence
```

Returns a sequence which contains the same elements as the collection. The order of the elements in the returned sequence is indefinite. If the collection is an instance of `ocl::Sequence`, then the method returns the sequence itself without creating a new sequence.

```
ocl::Collection::asBag( ) : ocl::Bag
```

Returns a bag which contains the same elements as the collection. If the collection is an instance of `ocl::Bag`, then the method returns the bag itself without creating a new bag.

2.8.4. Iterators

```
ocl::Collection::exists( boolExpr : ocl::Boolean ) : ocl::Boolean
```

Returns `true` if `boolExpr` evaluates to `true` for at least one element of the collection. Returns undefined if `boolExpr` evaluates to undefined for all elements of the collection. If the collection is empty, it returns `false`.

```
ocl::Collection::forall( boolExpr : ocl::Boolean ) : ocl::Boolean
```

Returns `true` if `boolExpr` evaluates to `true` for all element of the collection. Returns undefined if `boolExpr` evaluates to undefined for at least one element of the collection. If the collection is empty, it returns `true`.

```
ocl::Collection::isUnique( anyExpr : ocl::Any ) : ocl::Boolean
```

Returns `true` if `anyExpr` evaluates to a different value for each element of the collection.

```
ocl::Collection::any( boolExpr : ocl::Boolean ) : <innerType>
```

Returns any element of the collection for which `boolExpr` evaluates to `true`. If there is more than one element than one in the collection for which the condition is fulfilled, then one of them will be returned. If there are no elements, then undefined is returned.

```
ocl::Collection::one( boolExpr : ocl::Boolean ) : ocl::Boolean
```

Returns `true` if the collection contains exactly one element for which `boolExpr` evaluates to `true`.

```
ocl::Collection::sortedBy( anyExpr : ocl::Any ) : ocl::Sequence
```

This iterator is not implemented yet. OCL 1.4 specification has mistyped information about this iterator. It returns a sequence which contains all elements of the collection, where the order of the elements is determined by the value returned by `anyExpr` for the element.

2.9. ocl::Set

The type `ocl::Set` represents the mathematical concept of set.

2.9.1. Aliases, Supertypes

This type can be accessed as `Set`. Its supertype is `ocl::Collection`.

2.9.2. Operators

```
operator[ = ]( set1 : ocl::Set , set2 : ocl::Set ) : ocl::Boolean
```

Returns `true` if the size of `set1` and `set2` are the same, and `set1` contains all elements of `set2`, and `set2` contains all elements of `set1`.

```
operator[ <> ]( set1 : ocl::Set , set2 : ocl::Set ) : ocl::Boolean
```

Returns `true` if the size of `set1` and `set2` are not the same, or `set1` contains at least one element that `set2` does not, or `set1` contains at least one element that `set2` does not.

```
operator[ + ]( set1 : ocl::Set , set2 : ocl::Set ) : ocl::Set
```

```
operator[ + ]( set : ocl::Set , bag : ocl::Bag ) : ocl::Bag
```

Returns the union of `set1` and `set2`, or `set` and `bag`.

```
operator[ - ]( set : ocl::Set , collection : ocl::Collection ) : ocl::Set
```

Returns a set, which contains all elements that are contained in `set` but not in `collection`.

```
operator[ * ]( set1 : ocl::Set , set2 : ocl::Set ) : ocl::Set  
operator[ * ]( set : ocl::Set , bag : ocl::Bag ) : ocl::Set
```

Returns the intersection of `set1` and `set2`, or `set` and `bag`.

```
operator[ % ]( set1 : ocl::Set , set2 : ocl::Set ) : ocl::Set
```

Returns a set which contains all elements that are contained by only `set1` or `set2`.

2.9.3. Methods

```
ocl::Set::union( set : ocl::Set ) : ocl::Set  
ocl::Set::union( bag : ocl::Bag ) : ocl::Bag
```

Returns the union of the `set` and `set` or `bag`.

```
ocl::Set::subtract( collection : ocl::Collection ) : ocl::Set
```

Returns a set which contains all elements that are contained in `set` but not in `collection`.

```
ocl::Set::intersection( set : ocl::Set ) : ocl::Set  
ocl::Set::intersection( bag : ocl::Bag ) : ocl::Set
```

Returns the intersection of the `set` and `set` or `bag`.

```
ocl::Set::symmetricDifference( set : ocl::Set ) : ocl::Set
```

Returns a set which contains all elements that are contained by only the `set` or `set`.

```
ocl::Set::including( any : ocl::Any ) : ocl::Set
```

Returns a set containing `any`.

```
ocl::Set::excluding( any : ocl::Any ) : ocl::Set
```

Returns a set not containing `any`.

2.10. ocl::Bag

The type `ocl::Bag` represents the mathematical concept of multi-set (set containing elements multiple times).

2.10.1. Aliases, Supertypes

This type can be accessed as `bag`. Its supertype is `ocl::Collection`.

2.10.2. Operators

```
operator[ = ]( bag1 : ocl::Bag , bag2 : ocl::Bag ) : ocl::Boolean
```

Returns `true` if the size of `bag1` and `bag2` are the same, and `bag1` contains all elements of `bag2` with the same counts, and `bag2` contains all elements of `bag1` with the same counts.

```
operator[ <> ]( bag : ocl::Bag , collection : ocl::Collection ) : ocl::Boolean
```

Returns `true` if the size of `bag1` and `bag2` are not the same or `bag1` does not contain all elements of `bag2` with the same counts, or `bag2` does not contain all elements of `bag1` with the same counts.

```
operator[ + ]( bag : ocl::Bag , set : ocl::Set ) : ocl::Set
operator[ + ]( bag1 : ocl::Bag , bag2 : ocl::Bag ) : ocl::Bag
```

Returns the union of `bag` and `set`, or `bag1` and `bag2`.

```
operator[ * ]( bag : ocl::Bag , set : ocl::Set ) : ocl::Set
operator[ * ]( bag1 : ocl::Bag , bag2 : ocl::Bag ) : ocl::Bag
```

Returns the intersection of `bag` and `set`, or `bag1` and `bag2`.

2.10.3. Methods

```
ocl::Bag::union( set : ocl::Set ) : ocl::Bag
ocl::Bag::union( bag : ocl::Bag ) : ocl::Bag
```

Returns the union of the `bag` and `set` or `bag`.

```
ocl::Bag::intersection( set : ocl::Set ) : ocl::Set
ocl::Bag::intersection( bag : ocl::Bag ) : ocl::Bag
```

Returns the intersection of the `bag` and `set` or `bag`.

```
ocl::Bag::including( any : ocl::Any ) : ocl::Bag
```

Returns a bag containing `any`.

```
ocl::Bag::excluding( any : ocl::Any ) : ocl::Bag
```

Returns a bag not containing elements which equal to `any`.

2.10.4. Iterators

```
ocl::Bag::select( boolExpr : ocl::Boolean ) : ocl::Bag
```

Returns a bag containing all elements of the bag for which `boolExpr` evaluated to `true`.

```
ocl::Bag::reject( boolExpr : ocl::Boolean ) : ocl::Bag
```

Returns a bag containing all elements of the bag for which `boolExpr` evaluated to `false`.

```
ocl::Bag::collect( anyExpr : ocl::Any ) : ocl::Bag
```

Returns a bag containing values which are returned by `anyExpr` applied to each element of the bag.

2.11. ocl::Sequence

The type `ocl::Sequence` represents the mathematical concept of sequence.

2.11.1. Aliases, Supertypes

This type can be accessed as `Sequence`. Its supertype is `ocl::Collection`.

2.11.2. Operators

```
operator[ = ]( sequence1 : ocl::Sequence , sequence2 : ocl::Sequence ) : ocl::Boolean
```

Returns `true` if the size of `sequence1` and `sequence2` are the same, and if at each position the elements are equals to each other.

```
operator[ <> ]( sequence1 : ocl::Sequence , sequence2 : ocl::Sequence ) : ocl::Boolean
```

Returns true if size of `sequence1` and `sequence2` are not the same, or if at least one position exists in which elements are not equal.

```
operator[ + ]( sequence1 : ocl::Sequence , sequence2 : ocl::Sequence ) : ocl::Sequence
```

Returns the concatenation of `sequence1` and `sequence2`.

2.11.3. Methods

```
ocl::Sequence::union( sequence : ocl::Sequence ) : ocl::Sequence
```

Returns the concatenation of the sequence and `sequence`.

```
ocl::Sequence::append( any : ocl::Any ) : ocl::Sequence
```

Returns the `sequence` whose last element is `any`.

```
ocl::Sequence::prepend( any : ocl::Any ) : ocl::Sequence
```

Returns the `sequence` whose first element is `any`.

```
ocl::Sequence::first( ) : <innerType>
```

Returns the first element of the sequence. If the sequence is empty, an exception is thrown and undefined is returned.

```
ocl::Sequence::last( ) : <innerType>
```

Returns the last element of the sequence. If the sequence is empty, an exception is thrown and undefined is returned.

```
ocl::Sequence::at( pos : ocl::Integer ) : <innerType>
```

Returns the element at the position `pos` of the sequence. If `pos` is less than 0, or if it is greater than or equal to the size of the sequence, an exception is thrown and the result is undefined.

```
ocl::Sequence::insertAt( pos : ocl::Integer , any : ocl::Any ) : ocl::Sequence
```

Returns the sequence which contains `any` at position `pos`. If `pos` is less than 0, or if it is greater than or equal to the size of the sequence, an exception is thrown and the result is undefined.

```
ocl::Sequence::indexOf( any : ocl::Any ) : ocl::Integer
```

Returns the first position of the sequence where `any` is found. If there is no element, which equals to `any`, then return -1.

```
ocl::Sequence::subSequence( lower : ocl::Integer {, upper : ocl::Integer } ) :  
  ocl::Sequence
```

Returns the sub-sequence of the sequence starting at position `lower` up to position `upper`, if `upper` is specified; otherwise, up to the end of the sequence. The first position is 0. Returns undefined and an exception is thrown if `lower` is less than 0, `lower` greater than `upper`, or if `lower` or `upper` are equal to or greater than the size of the sequence.

```
ocl::Sequence::including( any : ocl::Any ) : ocl::Sequence
```

Returns a sequence containing `any`, the position of insertion is indefinite.

```
ocl::Sequence::excluding( any : ocl::Any ) : ocl::Sequence
```

Returns a sequence which does not contain any objects which are equal to `any`.

2.11.4. Iterators

`ocl::Sequence::select(boolExpr : ocl::Boolean) : ocl::Sequence`

Returns a sequence containing all elements for which `boolExpr` evaluated to `true`.

`ocl::Sequence::reject(boolExpr : ocl::Boolean) : ocl::Sequence`

Returns a sequence containing all elements for which `boolExpr` evaluated to `false`.

`ocl::Sequence::collect(anyExpr : ocl::Any) : ocl::Sequence`

Returns a sequence containing elements which are returned by `anyExpr` applied to each element of the sequence.

3. GME Kinds and Meta-Kinds

This section discusses the meta-kinds and predefined kinds of GME, and all features are described in detail.

Features, which are already deprecated, are marked with (D).

All features throw an exception if the object is null.

3.1. `gme::Object`

The meta-kind `ocl::Object` is the super-meta-kind of all meta-kinds of GME. It can be contained by folders.

3.1.1. Aliases, Super-Meta-Kind

This meta-kind can also be accessed as `Object`.

3.1.2. Operators

```
operator[ = ]( object1 : gme::Object , object2 : gme::Object ) : ocl::Boolean
```

Returns `true` if `object1` is the same as `object2`. This equality means that the objects' IDs are the same.

```
operator[ <> ]( object1 : gme::Object , object2 : gme::Object ) : ocl::Boolean
```

Returns `true` if `object1` is not the same as `object2`. This inequality means that the objects' IDs are different.

3.1.3. Attributes

```
gme::Object::name : ocl::String
```

Returns the name of the object.

```
gme::Object::kindName : ocl::String
```

Returns the name of the kind of the object.

```
gme::Object::metaKindName : ocl::String
```

Returns the name of the meta-kind of the object.

3.1.4. Methods

```
gme::Object::name( ) : ocl::String (D)
```

This method has the same functionality as the `gme::Object::name` attribute.

```
gme::Object::kindName( ) : ocl::String (D)
```

This method has the same functionality as the `gme::Object::kindName` attribute.

```
gme::Object::parent( ) : gme::Object
```

Returns the parent of the object. The result can be an object whose dynamic meta-kind is either `gme::Folder` or `gme::Model`. Returns `null` if the object is the root folder of the project.

```
gme::Object::isNull( ) : ocl::Boolean
```

Returns `true` if the object is `null`. In GME `null` differs from `undefined`.

```
gme::Object::isFCO( ) : ocl::Boolean
```

Returns true if the meta-kind of the object is `gme::FCO` or any descendant meta-kinds.

```
gme::Object::isFolder( ) : ocl::Boolean
```

Returns true if the meta-kind of the object is `gme::Folder`.

3.2. `gme::Folder`

The meta-kind `gme::Folder` represents a folder. A folder may contain objects which have meta-kind `gme::Object`.

3.2.1. Aliases, Super-Meta-Kind

This meta-kind can also be accessed as `Folder`. Its super-meta-kind is `gme::Object`.

3.2.2. Method

```
gme::Folder::folders( ) : ocl::Set( gme::Folder )
```

Returns a `set` which contains all folders recursively contained by the folder.

```
gme::Folder::childFolders( ) : ocl::Set( gme::Folder )
```

Returns a `set` which contains all folders contained by the folder.

```
gme::Folder::rootDescendants( ) : ocl::Set( gme::FCO )
```

Returns a `set` which contains all `fcos` which are either root objects in the folder or in all folders that the folder contains recursively.

```
gme::Folder::rootChildren( ) : ocl::Set( gme::FCO )
```

Returns a `set` which contains all `fcos` which are root objects of the folder.

```
gme::Folder::models( { kind : ocl::String } ) : ocl::Set( gme::Model ) (D)
gme::Folder::models( { kind : ocl::Type } ) : ocl::Set( gme::Model )
```

Returns a `set` which contains all models contained by the folder or by any child folder or model that the folder contains recursively. If `kind` is specified, then the set returned will contain objects with kind `kind`.

If the kind of `kind` (i.e. the meta-kind) is not `gme::Model`, then an exception is thrown and `undefined` is returned.

```
gme::Folder::atoms( { kind : ocl::String } ) : ocl::Set( gme::Atom ) (D)
gme::Folder::atoms( { kind : ocl::Type } ) : ocl::Set( gme::Atom )
```

Returns a `set` which contains all atoms contained by the folder, or by any child folder or model that the folder contains recursively. If `kind` is specified, then the set returned will contain objects with kind `kind`.

If the kind of `kind` (i.e. the meta-kind) is not `gme::Atom`, then an exception is thrown and `undefined` is returned.

3.3. `gme::FCO`

The meta-kind `gme::FCO` represents a first class object. `gme::FCO` can be contained by a `gme::Model` or a `gme::Folder`, be associated to any `gme::FCO`, inherit properties by either standard or interface

or implementation inheritance (only in time of meta- modeling), have attributes, be contained by a `gme::Set`, and last but not least be referred by a `gme::Reference`.

3.3.1. Aliases, Super-Meta-Type

This meta-kind can also be accessed as `FCO`. Its super-meta-kind is `gme::Object`.

3.3.2. Attributes

```
gme::FCO::roleName : ocl::String
```

Returns the name of the role of the `fco`, which is contained by a model.

3.3.3. Methods

```
gme::FCO::roleName( ) : ocl::String (D)
```

This method has the same functionality as `gme::FCO::roleName`.

```
gme::FCO::connected( { role : ocl::String {, kind : ocl::String } } ) :
  ocl::Set( gme::FCO ) (D)
gme::FCO::connectedFCOs( { role : ocl::String {, kind : ocl::String } } ) :
  ocl::Set( gme::FCO ) (D)
gme::FCO::connectedFCOs( { role : ocl::String {, kind : ocl::Type } } ) :
  ocl::Set( gme::FCO )
gme::FCO::connectedFCOs( kind : ocl::Type ) : ocl::Set( gme::FCO )
gme::FCO::bagConnectedFCOs( { role : ocl::String {, kind : ocl::Type } } ) :
  ocl::Bag( gme::FCO )
gme::FCO::bagConnectedFCOs( kind : ocl::Type ) : ocl::Bag( gme::FCO )
```

Returns a `set` or a `bag` which contains all `fcos` that are associated with the `fco`. If `role` is specified, then it returns only those, which have the same role in the link. If `kind` is specified, the kind of connections must be `kind`.

If the kind of `kind` (i.e. the meta-kind) is not `gme::Connection`, then an exception is thrown and undefined is returned.

```
gme::FCO::connectedAs( { role : ocl::String {, kind : ocl::String } } ) :
  ocl::Set( gme::FCO ) (D)
gme::FCO::reverseConnectedFCOs( { role : ocl::String {, kind : ocl::String } } ) :
  ocl::Set( gme::FCO ) (D)
gme::FCO::reverseConnectedFCOs( { role : ocl::String {, kind : ocl::Type } } ) :
  ocl::Set( gme::FCO )
gme::FCO::reverseConnectedFCOs( kind : ocl::Type ) : ocl::Set( gme::FCO )
gme::FCO::bagReverseConnectedFCOs( { role : ocl::String {, kind : ocl::Type } } ) :
  ocl::Bag( gme::FCO )
gme::FCO::bagReverseConnectedFCOs( kind : ocl::Type ) : ocl::Bag( gme::FCO )
```

Returns a `set` or a `bag` which contains all `fcos` that are associated with this `fco`. If `role` is specified, then only the links in which the `fco` takes part as role are regarded. If `kind` is specified, the kind of connections must be `kind`.

If the kind of `kind` (i.e. the meta-kind) is not `gme::Connection`, then an exception is thrown and undefined is returned.

```
gme::FCO::attachingConnPoints ( { role : ocl::String {, kind : ocl::String } } ) :
  ocl::Set( gme::ConnectionPoint ) (D)
gme::FCO::attachingConnPoints ( { role : ocl::String {, kind : ocl::Type } } ) :
  ocl::Set( gme::ConnectionPoint )
gme::FCO::attachingConnPoints ( kind : ocl::Type ) : ocl::Set( gme::ConnectionPoint )
```

Returns a set which contains all connection points (association ends) of the `fco`. If `role` is specified, then the role of the connection point has to match `role`. If `kind` is specified, the kind of connections must be `kind`.

If the kind of `kind` (i.e. the meta-kind) is not `gme::Connection`, then an exception is thrown and `undefined` is returned.

```
gme::FCO::attachingConnections ( { role : ocl::String {, kind : ocl::String } } ) :
  ocl::Set( gme::Connection ) (D)
gme::FCO::attachingConnections ( { role : ocl::String {, kind : ocl::Type } } ) :
  ocl::Set( gme::Connection )
gme::FCO::attachingConnections ( kind : ocl::Type ) : ocl::Set( gme::Connection )
```

Returns a set which contains all connections (instances of association class) that is a link of the `fco`. If `role` is specified, then the role of the connection point in the side of the `fco` has to match `role`. If `kind` is specified, the kind of the regarded connections must be `kind`.

If the kind of `kind` (i.e. the meta-kind) is not `gme::Connection`, then an exception is thrown and `undefined` is returned.

```
gme::FCO::isConnectedTo ( fco : gme::FCO {, role : ocl::String {, kind :
  ocl::String } } ) : ocl::Boolean (D)
gme::FCO::isConnectedTo ( fco : gme::FCO {, role : ocl::String {, kind :
  ocl::Type } } ) : ocl::Boolean
gme::FCO::isConnectedTo ( fco : gme::FCO, kind : ocl::Type ) : ocl::Boolean
```

Returns `true` if `fco` is connected to the `fco`. If `role` is specified, then the role of `fco` has to match `role`. If `kind` is specified, the kind of regarded connections must be `kind`.

If the kind of `kind` (i.e. the meta-kind) is not `gme::Connection`, then an exception is thrown and `undefined` is returned.

```
gme::FCO::subTypes( ) : ocl::Set( gme::FCO )
```

Returns a set which contains all `fcos` that are subtypes of the `fco`. Returns an empty set if the `fco` is not a type.

```
gme::FCO::instances( ) : ocl::Set( gme::FCO )
```

Returns a set which contains all `fcos` that are instances of this `fco` as a type. Returns an empty set if the `fco` is an instance.

```
gme::FCO::type( ) : gme::FCO
```

Returns the type of this `fco`.

```
gme::FCO::baseType( ) : gme::FCO
```

Returns the base type of this `fco`.

```
gme::FCO::isType( ) : ocl::Boolean
```

Returns `true` if the `fco` is a type.

```
gme::FCO::isInstance( ) : ocl::Boolean
```

Returns `true` if the `fco` is not a type, in which case it would be an instance.

```
gme::FCO::folder( ) : gme::Folder
```

Returns the closest folder which contains this `fco` recursively over models.

```
gme::FCO::referencedBy( { kind : ocl::String } ) : ocl::Set( gme::Reference ) (D)
```

```
gme::FCO::referencedBy( { kind : ocl::Type } ) : ocl::Set( gme::Reference )
```

Returns a set of references which refer to this fco. If kind is specified, then only those references whose kind is kind will be returned.

If the kind of kind (i.e. the meta-kind) is not gme::Reference, then an exception is thrown and undefined is returned.

```
gme::FCO::memberOfSets( { kind : ocl::String } ) : ocl::Set( gme::Set ) (D)
gme::FCO::memberOfSets( { kind : ocl::Type } ) : ocl::Set( gme::Set )
```

Returns a set of sets of GME that contains this fco. If kind is specified, then only those sets of GME whose kind is kind will be returned.

If the kind of kind (i.e. the meta-kind) is not gme::Set, then an exception is thrown and undefined is returned.

3.4. gme::Connection

The meta-kind gme::Connection corresponds to the well known UML meta-type called Association Class.

3.4.1. Aliases, Super-Meta-Type

This meta-kind can also be accessed as Connection. Its super-meta-kind is gme::FCO.

3.4.2. Methods

```
gme::Connection::connectionPoints( { role : ocl::String } ) :
  ocl::Set( gme::ConnectionPoint )
gme::Connection::connectionPoint( role : ocl::String ) : gme::ConnectionPoint
```

The first call returns a set of connection points (association ends) of the connection. If role is specified, then the role of the points has to match role. The second call ease the access only one connection point.

3.5. gme::Reference

The meta-kind gme::Reference is a special meta-kind of GME. It can be considered to be a pointer to an fco.

3.5.1. Aliases, Super-Meta-Type

This meta-kind can also be accessed as Reference. Its super-meta-kind is gme::FCO.

3.5.2. Methods

```
gme::Reference::usedByConnPoints( { kind : ocl::String } ) :
  ocl::Set( gme::ConnectionPoint ) (D)
gme::Reference::usedByConnPoints( { kind : ocl::Type } ) :
  ocl::Set( gme::ConnectionPoint )
```

Returns a set of connection points (association ends) of the reference in which the reference participates. With kind, we can filter those points which are only parts of connections having the same kind.

If the kind of kind (i.e. the meta-kind) is not gme::Reference, then an exception is thrown and undefined is returned.

```
gme::Reference::refersTo() : gme::FCO
```

Returns the fco to which the reference refers. The return object can be null if the reference points to null.

3.6. gme::Set

The meta-kind `gme::Set` corresponds to a set which can contains fcos.

3.6.1. Aliases, Super-Meta-Type

This meta-kind can also be accessed as `Set`. Its super-meta-kind is `gme::FCO`.

3.6.2. Methods

```
gme::Connection::members() : ocl::Set( gme::FCO )
```

Returns a set of fcos that are contained by the set of GME.

3.7. gme::Atom

The meta-kind `gme::Atom` is the meta-kind of those objects which are not abstract and have no more features than `gme::FCO`.

3.7.1. Aliases, Super-Meta-Type

This meta-kind can also be accessed as `Atom`. Its super-meta-kind is `gme::FCO`.

3.8. gme::Model

The meta-kind `gme::Model` is the abstraction of containers which can contain fcos.

3.8.1. Aliases, Super-Meta-Type

This meta-kind can also be accessed as `Model`. Its super-meta-kind is `gme::FCO`.

3.8.2. Methods

```
gme::Model::atomParts( { role : ocl::String } ) : ocl::Set( gme::Atom )
gme::Model::modelParts( { role : ocl::String } ) : ocl::Set( gme::Model )
gme::Model::connectionParts( { role : ocl::String } ) : ocl::Set( gme::Connection )
gme::Model::referenceParts( { role : ocl::String } ) : ocl::Set( gme::Reference )
gme::Model::setParts( { role : ocl::String } ) : ocl::Set( gme::Set )
gme::Model::parts( { role : ocl::String } ) : ocl::Set( gme::FCO )
gme::Model::atomParts( kind : ocl::Type ) : ocl::Set( gme::Atom )
gme::Model::modelParts( kind : ocl::Type ) : ocl::Set( gme::Model )
gme::Model::connectionParts( kind : ocl::Type ) : ocl::Set( gme::Connection )
gme::Model::referenceParts( kind : ocl::Type ) : ocl::Set( gme::Reference )
gme::Model::setParts( kind : ocl::Type ) : ocl::Set( gme::Set )
gme::Model::parts( kind : ocl::Type ) : ocl::Set( gme::FCO )
```

These methods return a set which contains the immediate children of the model.

For these methods we can specify a role name, which is the containment role of the object as it is contained by the model. This role may differ from the role that the user defined in the meta-model. This is the case

if the role is defined as an abstract kind in the meta-model. Because the inheritance information is lost the interpreter has to create distinguishable roles for the objects by concatenating the kind and the role.

If the kind of `kind` (i.e. the meta-kind) does not correspond to the method name, then an exception is thrown and `undefined` is returned.

```
gme::Model::models( { kind : ocl::String } ) : ocl::Set( gme::Model ) (D)
gme::Model::models( { kind : ocl::Type } ) : ocl::Set( gme::Model )
gme::Model::atoms( { kind : ocl::String } ) : ocl::Set( gme::Atom ) (D)
gme::Model::atoms( { kind : ocl::Type } ) : ocl::Set( gme::Atom )
```

These methods have the same functionality as the `parts` methods have, except these methods return the set of contained objects which are contained recursively by the model (its immediate children and its descendants' models' children). The returned set will contain objects that have the appropriate meta-kind.

3.9. `gme::Project`

This kind is predefined in GME, and has exactly one instance in all models. It is introduced to facilitate writing constraint definitions whose context cannot be any of the kinds defined in the paradigm.

3.9.1. Aliases, Supertypes

This kind can be accessed as `Project`. Its supertype is `ocl::Any`.

3.9.2. Operators

```
operator[ = ]( project1 : gme::Project, project2 : gme::Project ) : ocl::Boolean
operator[ <> ]( project1 : gme::Project, project2 : gme::Project ) : ocl::Boolean
```

These operators are defined because of consistency. But since there is only one instance of `gme::Project` in all projects, these features are useless.

3.9.3. Attributes

```
gme::project::name
```

Returns the name of the project.

This attribute can be used to check whether the project is included as a library in another project.

3.9.4. Methods

```
gme::project::allInstancesOf( kind : ocl::Type ) : ocl::Set( gme::Object )
```

Returns a set which contains all objects in the project whose kind is `kind`.

If `kind` is not defined in the paradigm, an exception is thrown and `undefined` is returned.

```
gme::project::rootFolder() : gme::RootFolder
```

Returns the root folder of the project.

3.10. `gme::RootFolder`

This kind is predefined in GME, and has exactly one instance in all projects. It is introduced because at meta-modeling time this folder has to be referred to somehow.

It does not have special features regarding its meta-kind `gme::Folder`.

3.10.1. Aliases, Supertypes, Meta-Type

This kind can be accessed as `RootFolder`. Its super-type is `ocl::Any`. Its meta-kind is `gme::Folder`.

3.11. `gme::ConnectionPoint`

This kind corresponds to association-end in GME. Using this kind is not recommended, because it serves meta-kind information and is not defined well in standard OCL. This kind will be likely eliminated and replaced by a standard type (`AssociationEnd`) in the new implementation of OCL.

3.11.1. Aliases, Supertypes

This kind can be accessed as `ConnPoint` or `ConnectionPoint`. Its super-type is `ocl::Any`.

3.11.2. Operators

```
operator[ = ]( cp1 : gme::ConnectionPoint, cp2 : gme::ConnectionPoint ) : ocl::Boolean
operator[ <> ]( cp1 : gme::ConnectionPoint, cp2 : gme::ConnectionPoint ) :
  ocl::Boolean
```

The first operator returns `true` if `cp1` and `cp2` have the same role, are attached to the same `fco`, and are connection-points of the same connection. If at least one of these conditions is not satisfied, it returns `false`.

The second operator returns `true` if at least one of these conditions is not satisfied.

3.11.3. Attributes

```
gme::ConnectionPoint::cpRoleName : ocl::String
```

Returns the role of the connection point.

3.11.4. Methods

```
gme::ConnectionPoint::cpRoleName() : ocl::String (D)
```

This method has the same functionality as the `gme::ConnectionPoint::cpRoleName` attribute.

```
gme::ConnectionPoint::target() : gme::FCO
```

Returns the `fco` to which this connection point is attached.

```
gme::ConnectionPoint::owner() : gme::Connection
```

Returns the connection that has this connection point.

```
gme::ConnectionPoint::peer() : gme::ConnectionPoint
```

If the connection point is owned by a binary connection, then it returns the other connection point of the connection, otherwise it throws an exception and returns `undefined`.

```
gme::ConnectionPoint::usedReferences() : ocl::Sequence( gme::FCO )
```

Returns a sequence which contains all references used by the connection point. The first reference is farthest from the target of the connection point.

Glossary

Glossary of Terms

aspects		The parts contained within a GME model are partitioned into viewable groups called aspects. Parts may be added or deleted only from their primary aspects, but may be visible in many secondary aspects.
CBS		Computer Based System
Compound model		A model that can contain other objects
connection		A line with a particular appearance and directionality joining two atomic parts or parts contained in models. In the GME, connections can have domain-specific attributes (accessed by right-clicking anywhere on the connection).
CORBA		Common Object Request Broker Architecture
COTS		Commercial off-the-shelf software
DSME		Domain Specific MIPS Environment
Generic Environment	Modeling	A configurable, multi-aspect, graphical modeling environment used in the MultiGraph Architecture
GME		See Generic Modeling Environment
GOTS		Government off-the-shelf software
interpreters		See Model interpreters
Link		See Link parts
Link parts		Atomic parts contained within a model that are visible, and can participate in connections, when the container model appears inside other models.
MCL		MGA constraint language. A subset of OCL, with MGA-specific additions.
Metamodel		A model that contains the specifications of a domain-specific MIPS environment (DSME). Metamodels contain syntactic, semantic, and presentation specifications of the target DSME.
metamodeling environment		A domain-specific MIPS environment (DSME) configured to allow the specification and synthesis of other DSMEs.
MGA		See MultiGraph Architecture
MGK		MultiGraph Kernel. Middleware designed to support real-time MultiGraph execution environments
MIC		Model Integrated Computing

MIPS	Model Integrated Program Synthesis
modeling paradigm	The syntactic, semantic, and presentation information necessary to create models of systems within a particular domain.
Model interpreters	High-level code associated with a given modeling paradigm, used to translate information found in the graphical models into forms (executable code, data streams, etc.) useful in the domain being modeled.
Model translators	See Model interpreters
MultiGraph Architecture	A toolset for creating domain-specific modeling environments.
OCL	Object Constraint Language (a companion language to UML)
paradigm	See modeling paradigm
POSIX	Portable Operating System Interface, An IEEE standard designed to facilitate application portability
Primitive model	A model that cannot contain other models
Reference parts	Objects that refer to (i.e. point to) other objects (atomic parts or models)
References	See Reference parts